

Desenho à Mão Livre

• Animais • Vegetais • Caricaturas • Sólidos geométricos • Linhas etc.



José F. Steck



DE - Edson Lima 1977
PARA - Casa de Cultura

Desenho à Mão Livre

José Francisco Steck

Desenho à Mão Livre

ao alcance de todos

- Linhas
- Ângulos e figuras planas
- Sólidos geométricos
- Vegetais
 - Paisagem e marinha
 - Animais
 - Figura humana

EDIÇÕES DE OURO

Livrarias EDIÇÕES DE OURO

RIO DE JANEIRO

- Bonsucesso:**
- Rua Nova Jerusalém, 345 (sede)
- Centro:**
- Av. Rio Branco, 156 — loja 4 (Ed. Avenida Central)
- Copacabana:**
- Rua Santa Clara, 33-D
- Jóquei Clube (Jardim Botânico):**
- Entre a Rua Jardim Botânico e Marques de São Vicente (Praça Santos-Dumont, 66)
- Méier:**
- Rua Dias da Cruz, 188 — loja 103
- Mariz e Barros:**
- Rua Mariz e Barros, 290 (em frente ao Instituto de Educação)
- Madureira:**
- Rua D. Clara, 11 — loja F (esquina de Domingos Lopes)

NOVA IGUAÇU

- Av. Floriano Peixoto, 1784 — loja 2 (Galeria Fluminense)

NITERÓI

- Rua Gavião Peixoto, 92 — loja 103 (Beco do Príncipe) — Icaraí

DUQUE DE CAXIAS

- Av. Plínio Casado, 58 — loja E (em frente à passarela do mercado)

SÃO PAULO

- Centro:**
- Rua Conselheiro Crispiniano, 403
- Centro:**
- Rua Benjamim Constant, 162
- Penha:**
- Av. Penha de França, 771

BELO HORIZONTE

- Av. Afonso Pena, 1707 (perto do Palácio das Artes)

CURITIBA

- Rua Jesuíno Marcondes, 33 — loja 1 (quase esquina da Pç. Gal. Osório)

PORTO ALEGRE

- Av. Ipiranga, 2821 (em frente ao Supermercado Zaffari)

FORTALEZA

- Rua Major Facundo, 680

RECIFE

- Rua do Hospício, 202 — loja 2 — Ed. Olympia

SALVADOR

- Av. 7 de Setembro, esquina da Rua Politeama de Cima (Mercês)

BRASÍLIA

- Super Center Venâncio 2000 — 1.º Subsolo — loja 42-F

PREFÁCIO

José Francisco Steck

Desenhar é fácil, como escrever é fácil, desde que se parta do mais simples para o mais complexo, desde que se tenha método.

Desenhar é útil e divertido.

Fácil, útil e divertido são os três aspectos com que apresentamos o Desenho neste livrinho, dedicado a todos:

- 1) às crianças que estejam iniciando seus primeiros passos no Desenho, quer em casa, quer na escola primária, como um meio para desenvolver a observação, o senso de equilíbrio, o raciocínio, o gosto, os bons hábitos de higiene;
- 2) aos adultos, como passatempo de férias ou aos domingos e feriados, nas noites chuvosas, etc., ou como terapêutica adequada para o sistema nervoso, nesse nosso mundo atual tão agitado, tão cheio de angústias;
- 3) aos adolescentes, em casa ou nos ginásios, sob a orientação sábia e experiente dos professores, como livro adotado nas primeiras séries ginásiais, complementando assim as explicações e os traçados feitos nos quadros e tornando a matéria agradável;



- 4) aos professores de *Desenho e Artes Industriais*, que encontrarão no livrinho motivação para as aulas, uma vez que as ilustrações são apoiadas nos itens dos programas de *Desenho e Matemática*, tais como o estudo das linhas, dos ângulos, das figuras planas, dos sólidos geométricos, das letras simples, do desenho decorativo, etc.

As paisagens, as flores, os frutos, os motivos de decoração poderão ser ampliados e coloridos com gouache, aquarela, lápis de cor ou lápis-cera.

As figuras do livro, em sua maioria, são desprovidas de sombreado e apresentam grande simplicidade, mas há, aqui e ali, ilustrações mais trabalhadas, que quebram a monotonia do conjunto, dando mais graça ao livro e estimulando os mais estudiosos.

Você, que vai usar o livrinho, poderá desenhar as figuras que quiser, mas se seguir a ordem em que elas se apresentam lucrará mais, pois estão, em sua maioria, em ordem de dificuldade crescente.

Observe as recomendações feitas quanto ao uso do material e confie em si próprio, pois estou certo que obterá êxito.

Felicidades,

O Autor

MATERIAL

O material indispensável é muito simples e de baixo preço:

- 1) Papel de desenho. Poderá ser um pedaço de papel canson ou folha de bloco ou ainda caderno de desenho. O papel não deve ter pautas;
- 2) Um lápis n.º 2 ou H. B. ou ainda o preto da caixa de lápis de cores;
- 3) Uma borracha branca bem macia;
- 4) Uma lâmina e um pedaço de lixa para apontar o lápis.

RECOMENDAÇÕES

- 1) O estudante deverá manter sempre bem apontado o lápis;
- 2) A ponta deverá ser feita com a lâmina e afinada na lixa. Com um trapinho o estudante limpará os dedos e o lápis sempre que acabar de fazer a ponta, para que não suje o papel de desenho.
- 3) Todo o cuidado com o material é pouco. Um lápis que cai ao solo, por exemplo, poderá não servir mais.
- 4) Todo desenho deverá ser começado da esquerda para a direita e de cima para baixo. Os desenhos de figuras deverão ser começados pela cabeça.
- 5) Os preceitos de higiene deverão ser observados: luz pela esquerda, posição correta, afastamento dos olhos ao papel de uns trinta centímetros. O material nunca deverá ser levado à boca.

BIBLIOGRAFIA

- A Arte do Desenho** — Carlos Reis
O Discípulo Parisiense — Monsoco Irmãos Editores, Paris
Wie Lerne Ich Zeichnen — J. Manfreda

ROTEIRO

- Capítulo I** — Linhas retas, curvas, quadradas ou poligonais, mistas, sinuosas, verticais, horizontais, inclinadas, paralelas, perpendiculares, oblíquas. Letras. Objetos. Desenho decorativo.
- Capítulo II** — Ângulos retos, obtusos, agudos. Objetos.
Polígonos:
a) triângulo equilátero, isósceles, escaleno, retângulo, acutângulo, obtusângulo, curvilíneo, mistilíneo.
b) paralelogramos: quadrado, retângulo, romboide, rombo ou losango.
c) trapézio retângulo, isósceles, escaleno.
Letras, objetos, desenho decorativo.
Circunferência e círculo. Raio, diâmetro. Círculos concêntricos e excêntricos. Oval. Arcos. Objetos. Desenho decorativo.
- Capítulo III** — Sólidos geométricos:
a) paralelepípedos; hexaedro ou cubo;
b) prisma e pirâmide; objetos prismáticos e piramidados.
c) sólidos de revolução: cilindro, cone e esfera; objetos cilíndricos, cônicos, esféricos.
Objetos simétricos (eixo de simetria).
- Capítulo IV** — Vegetais — folhas, flores e frutos. Comparação com a forma de certos objetos.
- Capítulo V** — Paisagem e marinha — árvores, casas, meios de transporte antigos e modernos.
- Capítulo VI** — Animais — peixes, moluscos, répteis, insetos, aves, mamíferos de pequeno e grande portes, proporção do cavalo e do boi. Desenho decorativo com motivos da fauna estilizada. Caricatura de animais.
- Capítulo VII** — Figura humana:
a) Cabeças — proporções, pormenores da cabeça (olhos, narizes, bocas, orelhas), expressões fisionômicas, caricaturas, alguns tipos do Brasil.
b) Partes do vestuário: chapéus, sapatos;
c) Mãos;
d) Figura completa: proporções, pequenas cenas, caricaturas.

CAPÍTULO I
*
LINHAS



1,7cm 0,8cm
2,5cm



Vertical line tracing practice consisting of two groups of ten parallel vertical lines.

Horizontal line tracing practice consisting of three groups of five parallel horizontal lines.

Tracing practice for the letter 'H', including two groups of vertical lines and two 'H' characters with dashed lines for tracing.

Tracing practice for the letters 'E', 'F', 'H', 'I', 'L', and 'T', each shown as a solid outline.

Diagonal line tracing practice consisting of seven parallel diagonal lines sloping upwards from left to right.

Diagonal line tracing practice consisting of seven parallel diagonal lines sloping downwards from left to right.

Tracing practice for the letters 'A', 'W', 'M', and 'M', each shown as a solid outline.

Tracing practice for the letters 'N', 'K', 'X', 'Y', '4', and 'Z', each shown as a solid outline.

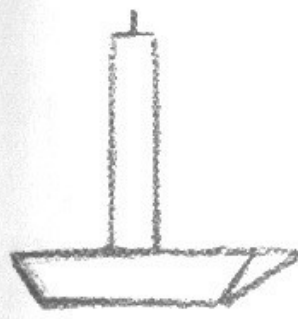
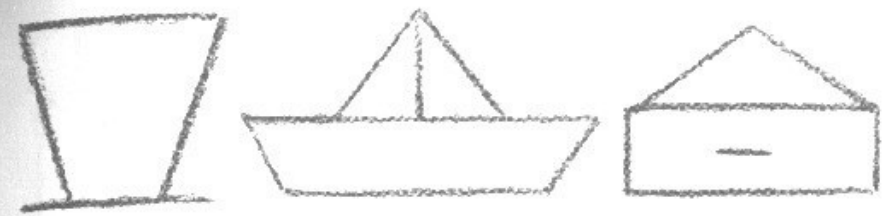
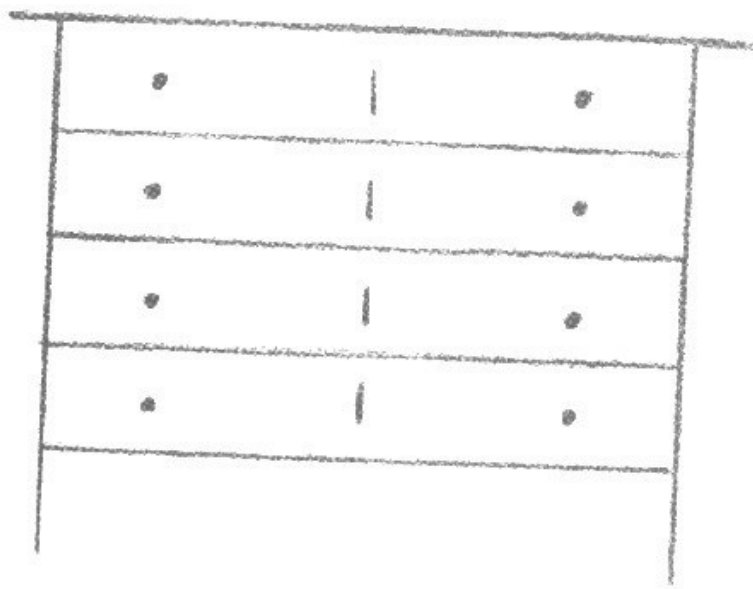
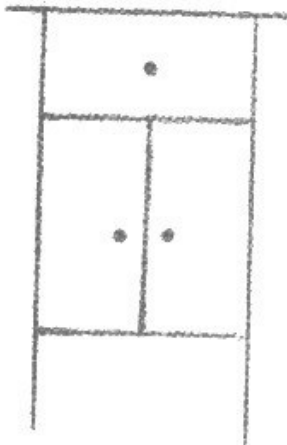
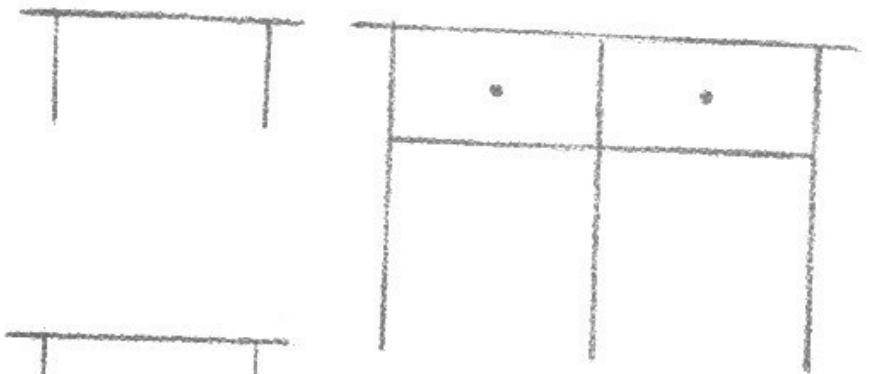

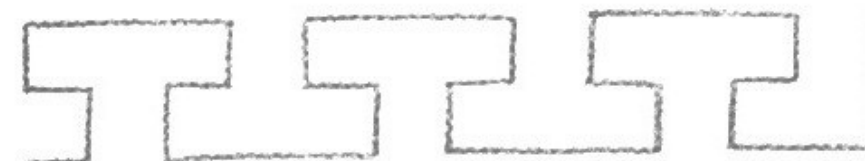
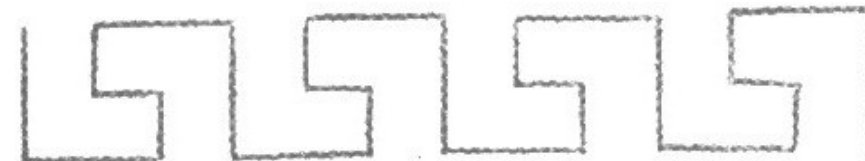
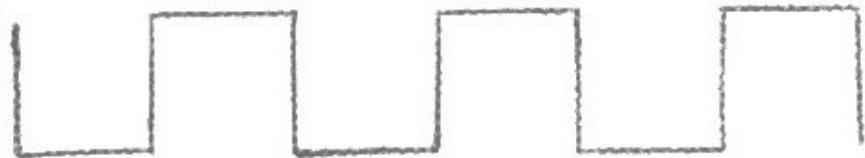
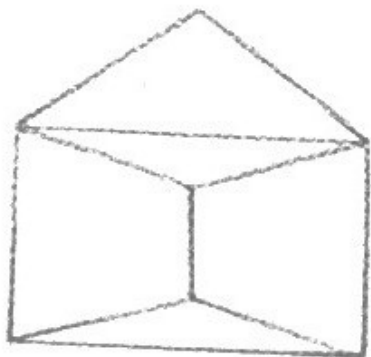
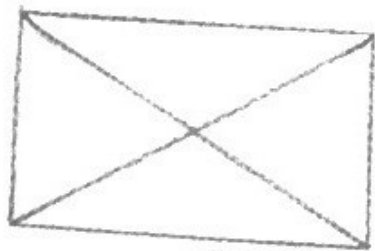
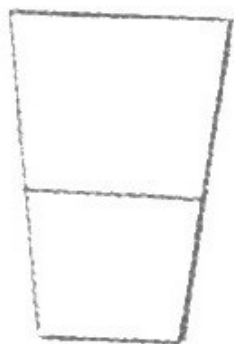
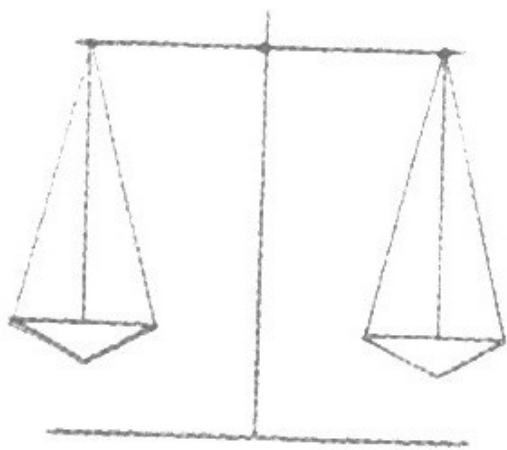
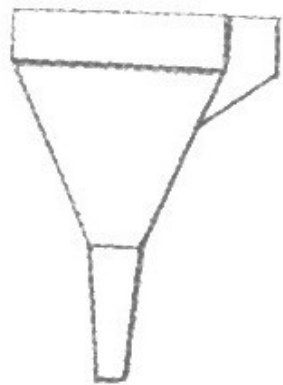
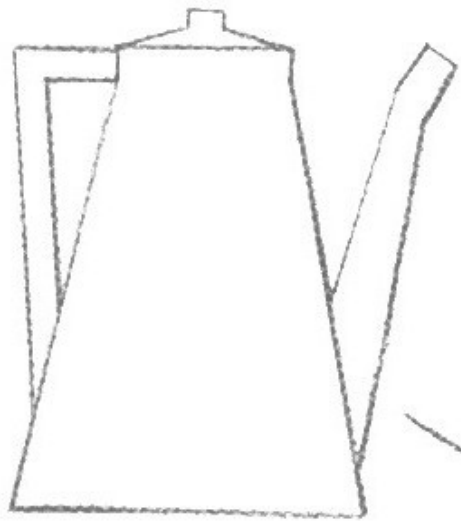

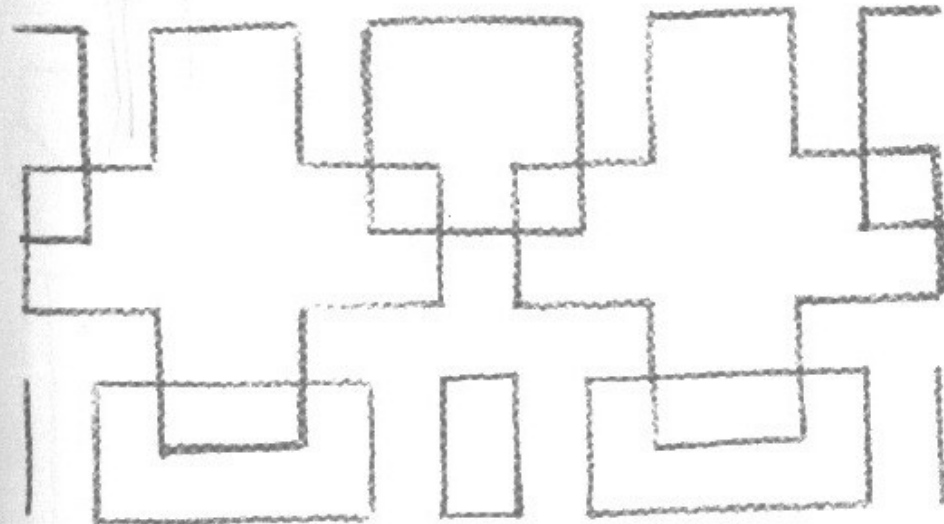
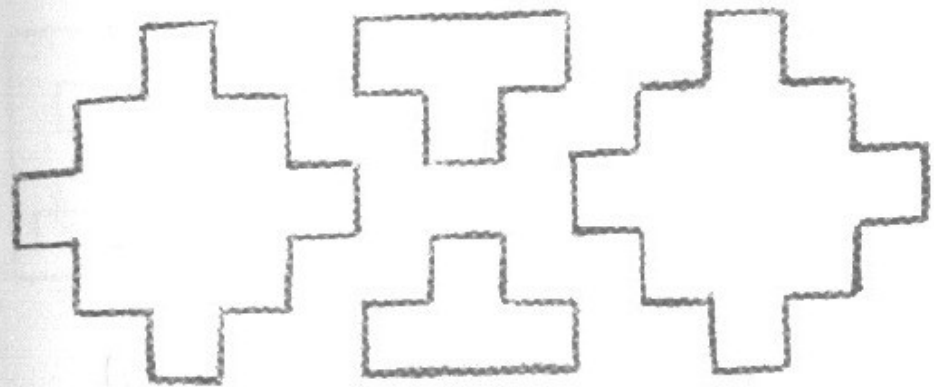
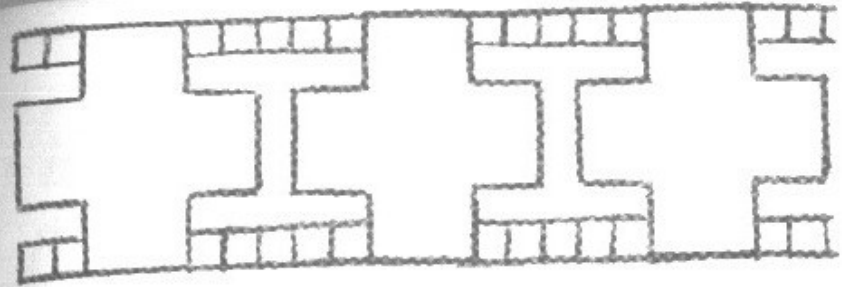
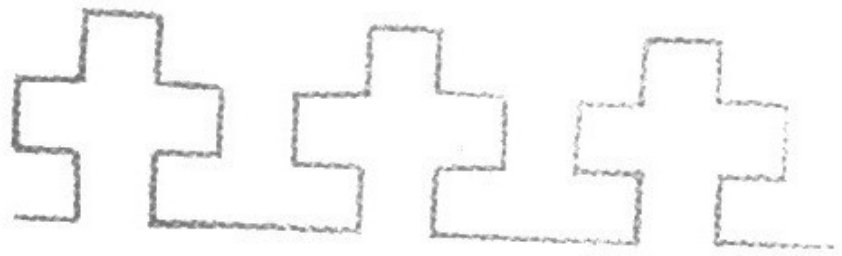
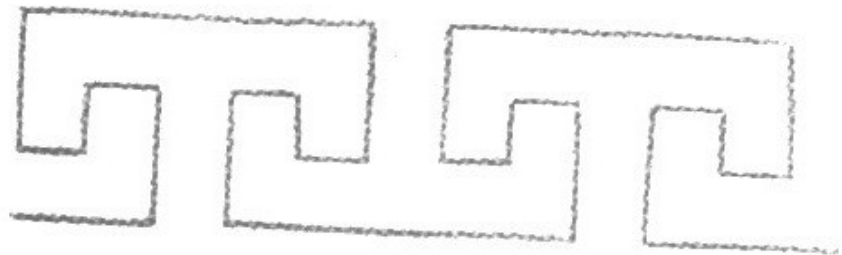
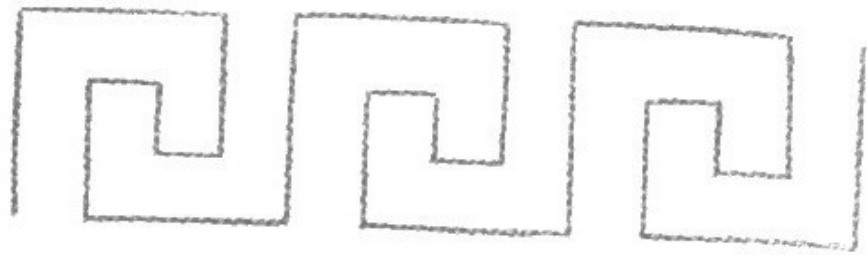

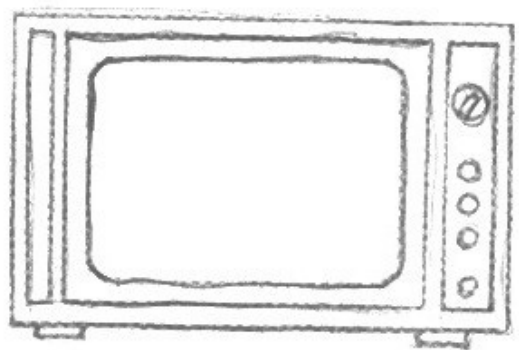
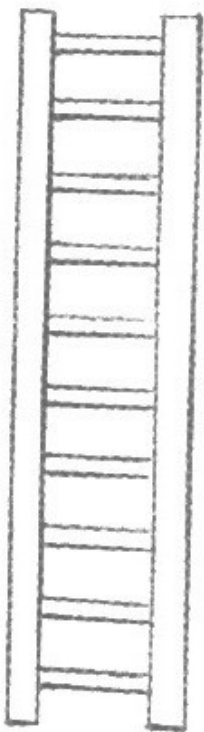
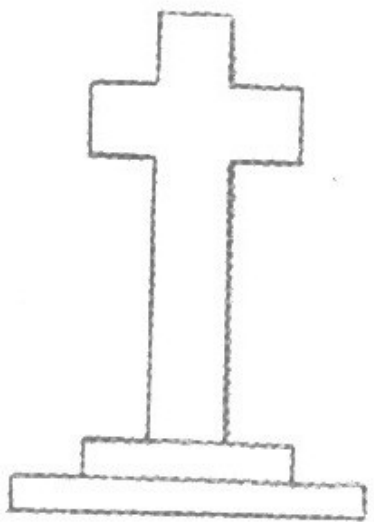
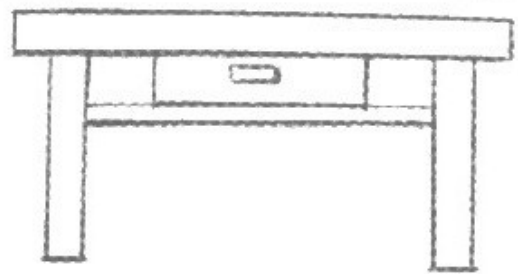

A B C D

E F G H

J K L P

I M N R

T L E H

O Q S T

U V X Y

Z W 1 7

2 3 4 5

O O C

C D P R

B 3 2 8

U 9 6 5 S

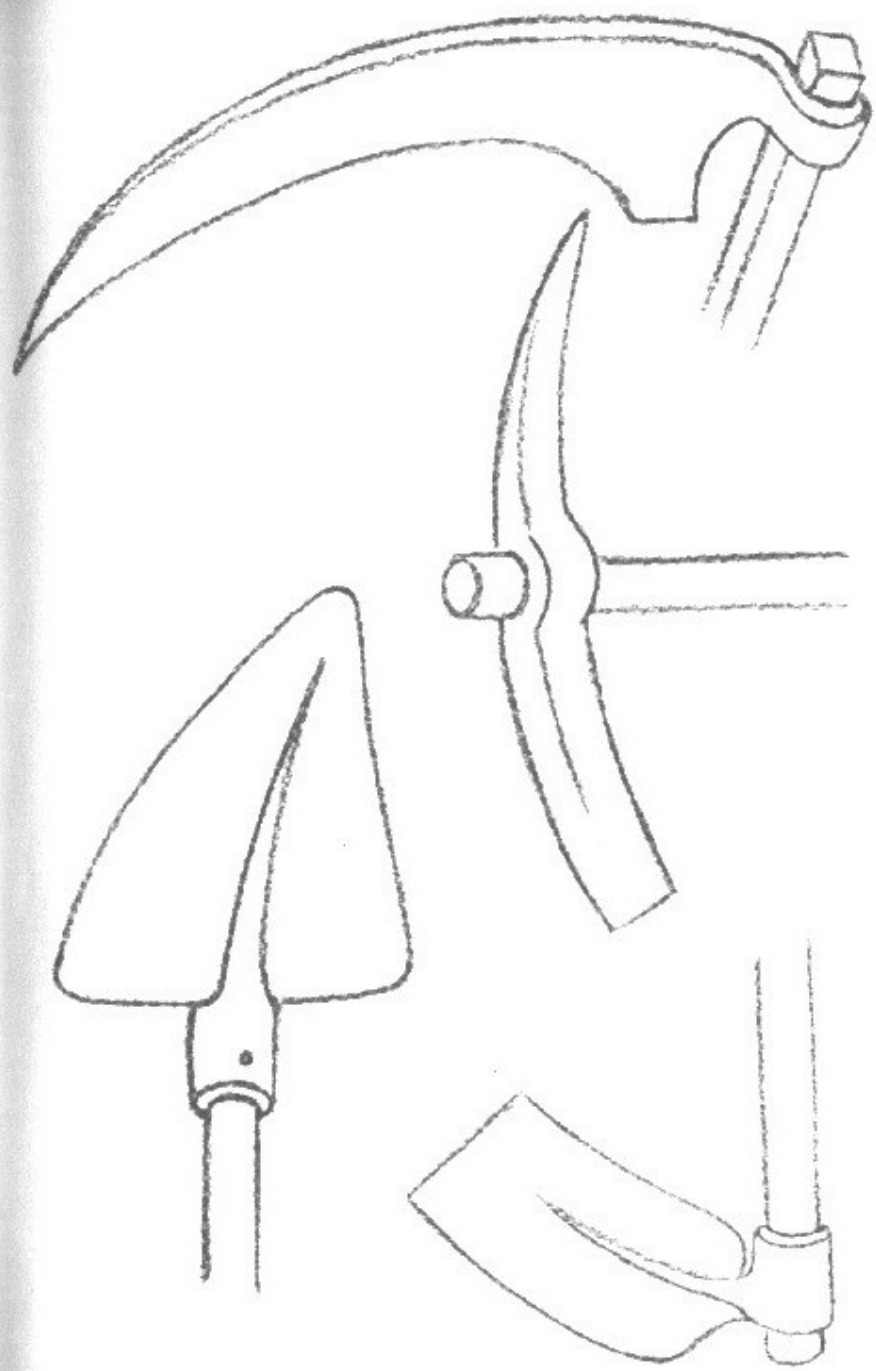
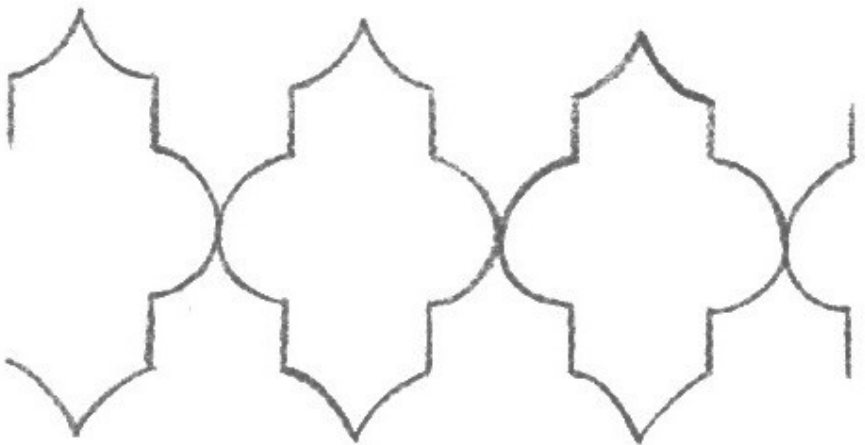
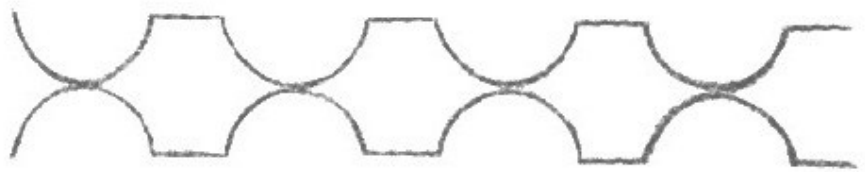
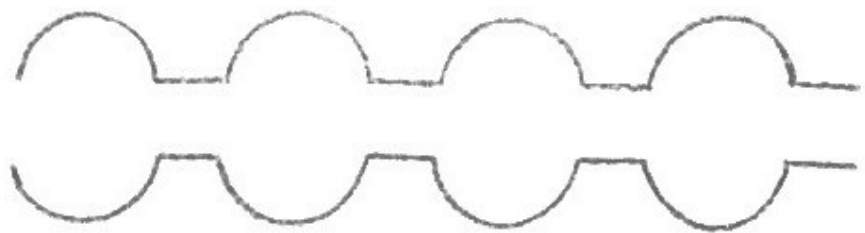

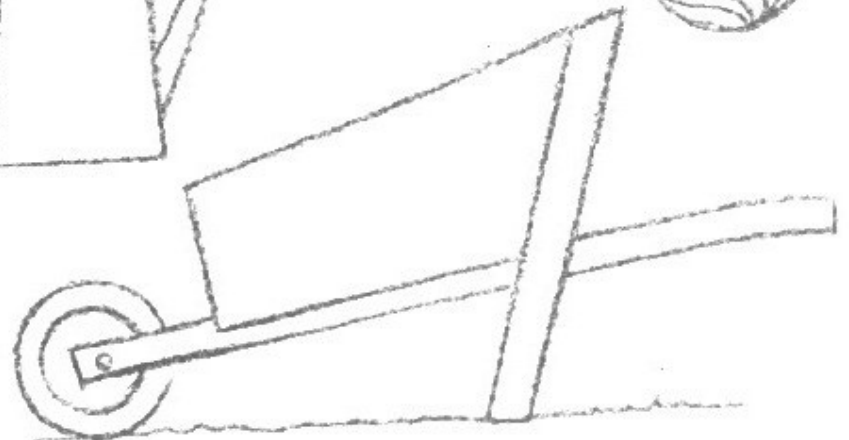
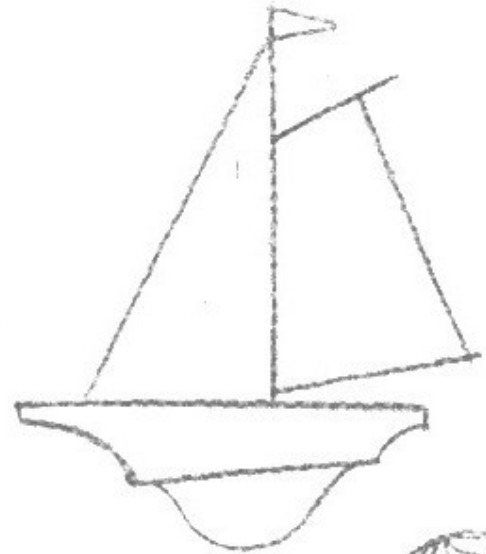
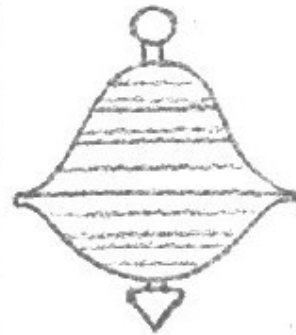
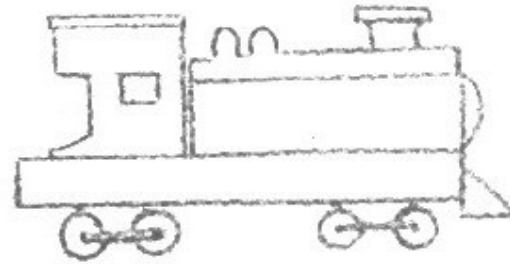
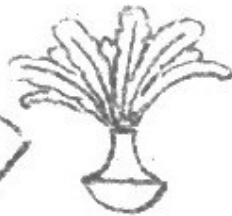
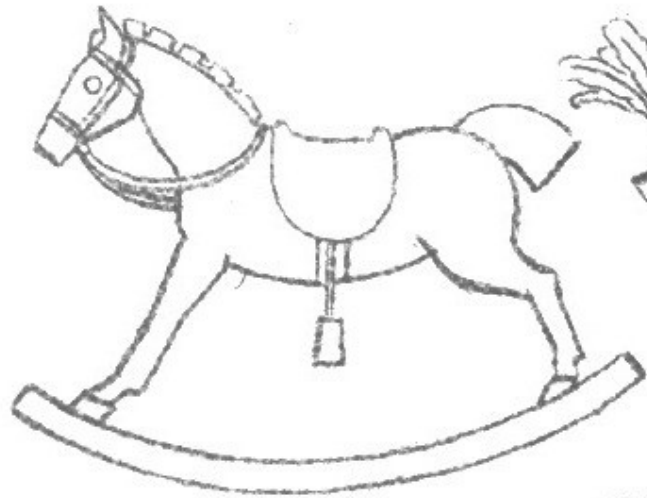
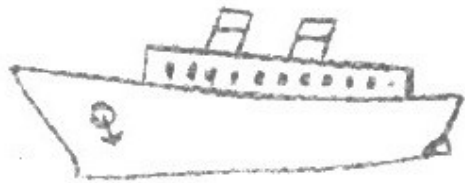
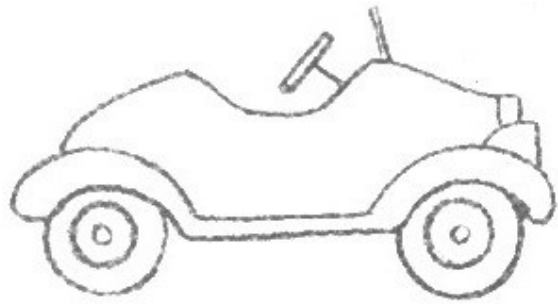

CAPITULO II
*
ÂNGULOS E FIGURAS PLANAS

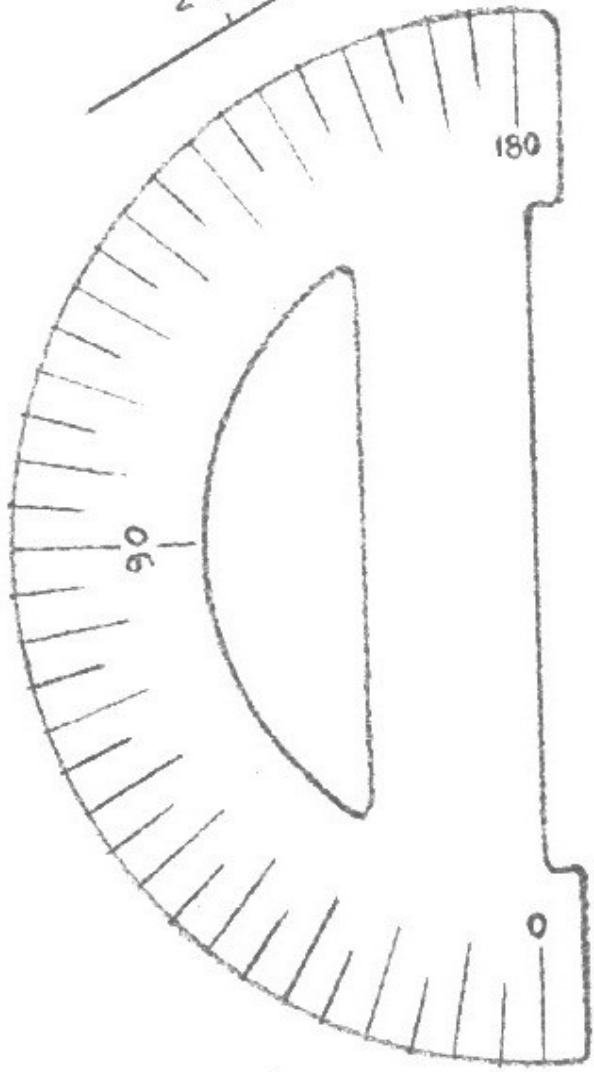
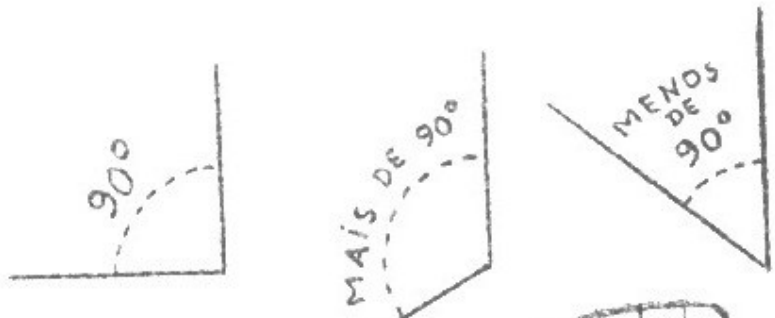

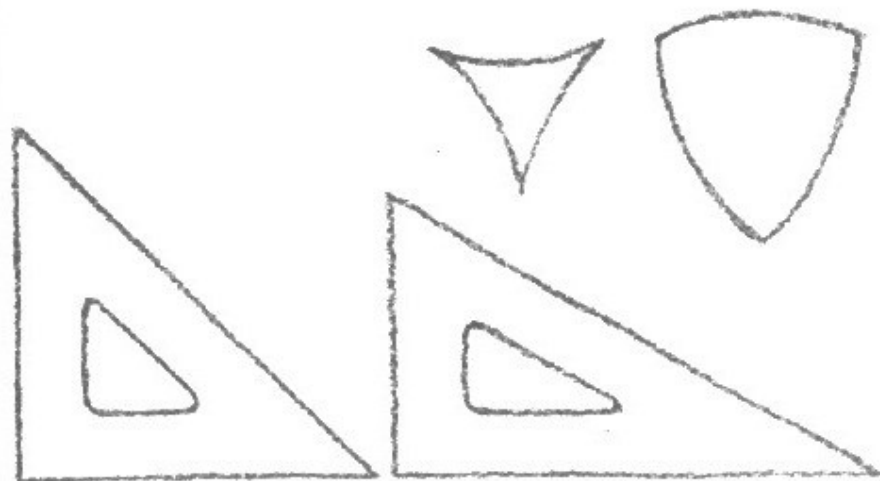
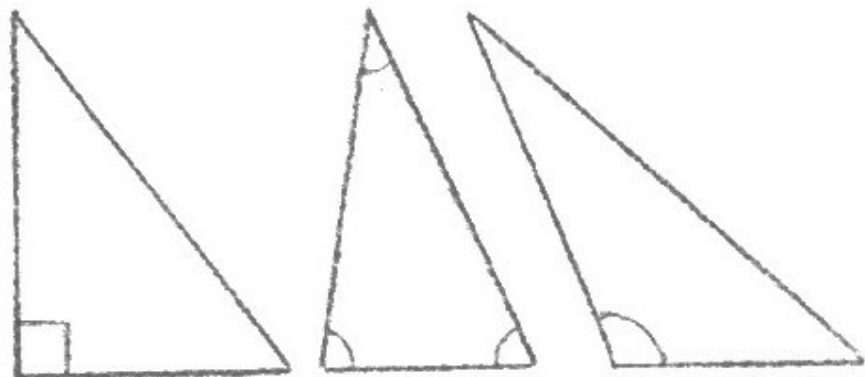
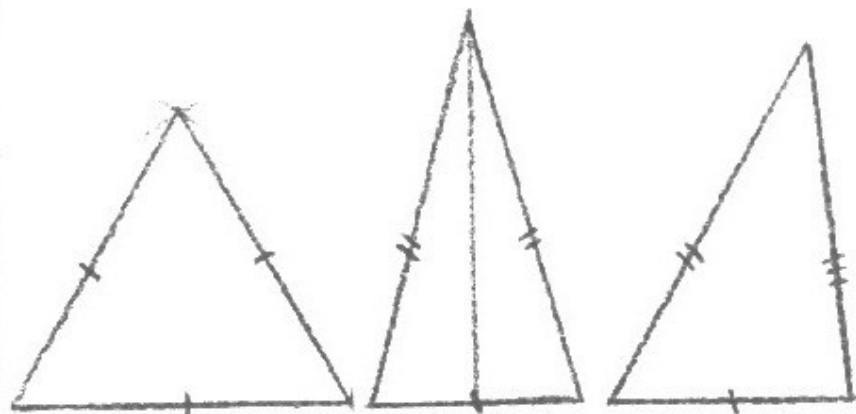
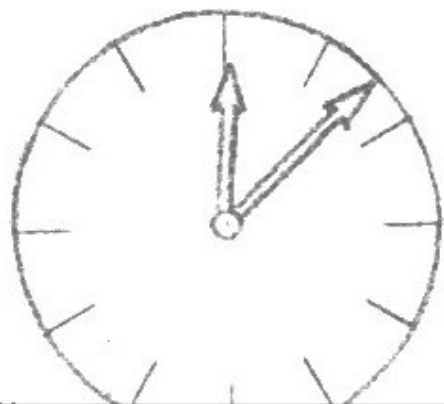
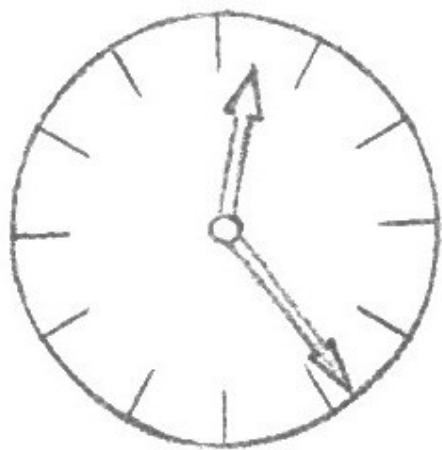
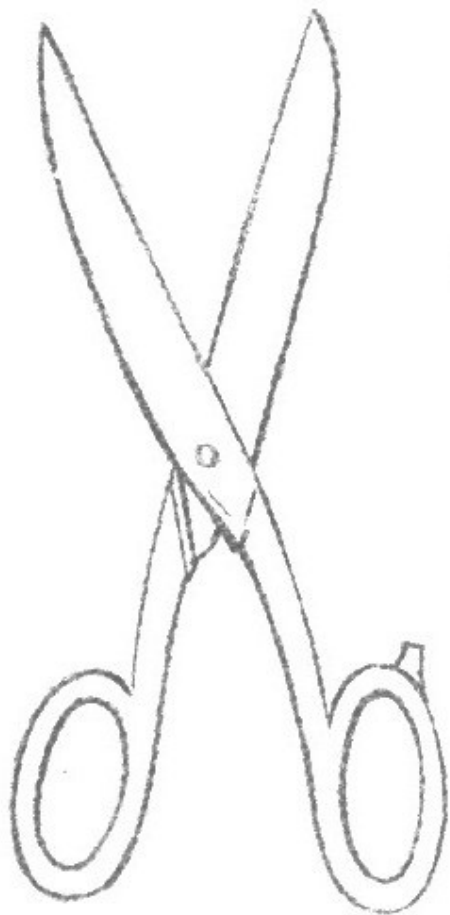
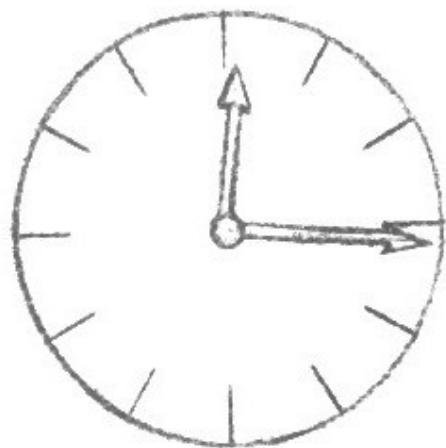
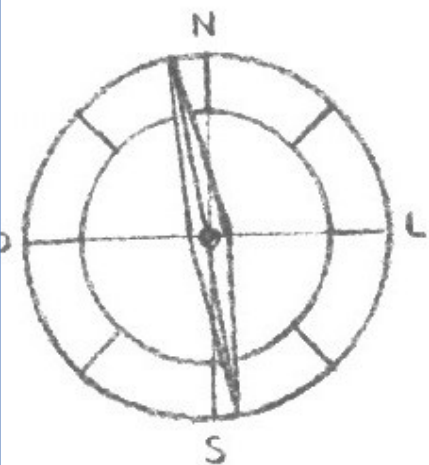

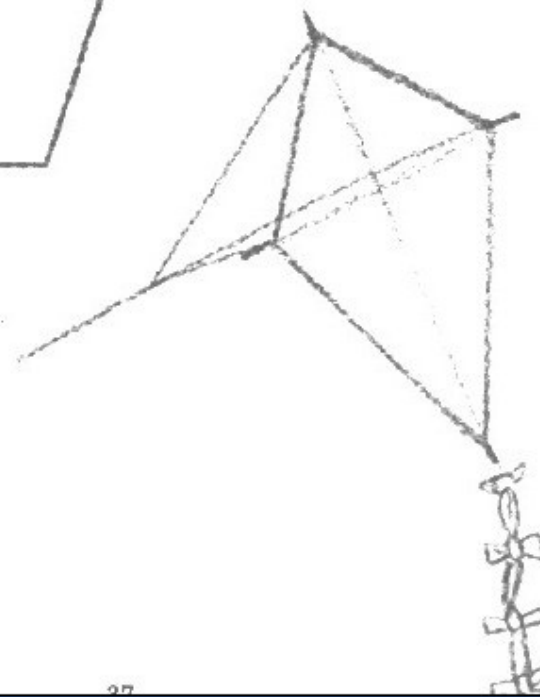
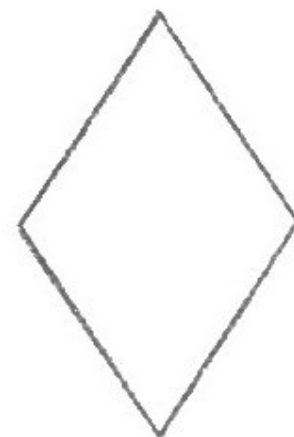
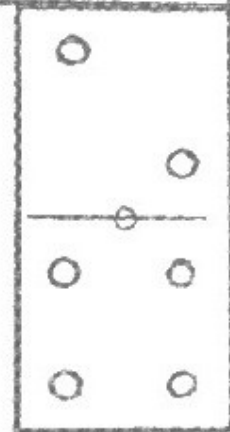
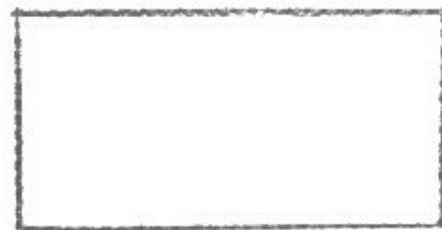
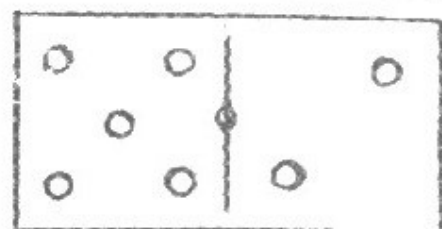
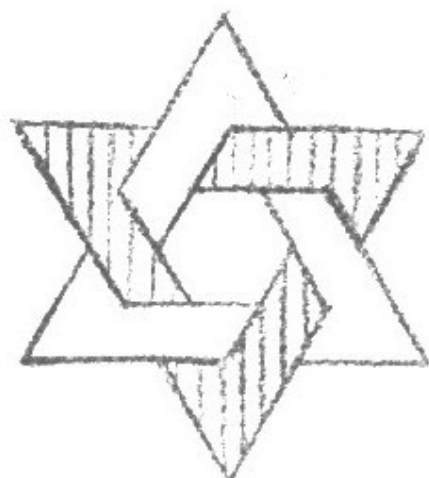
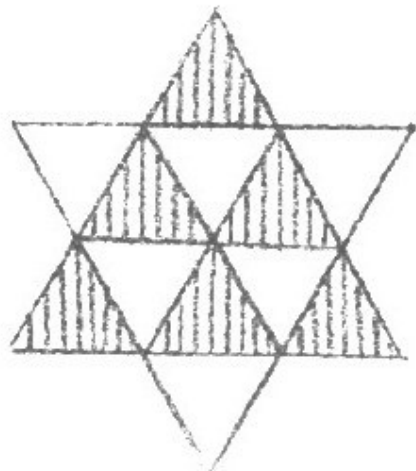
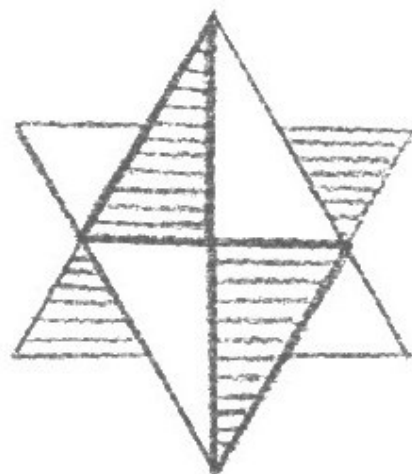
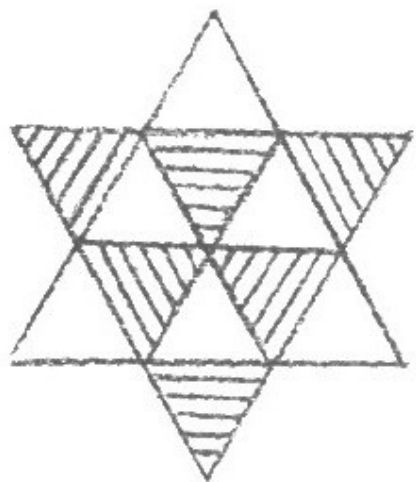
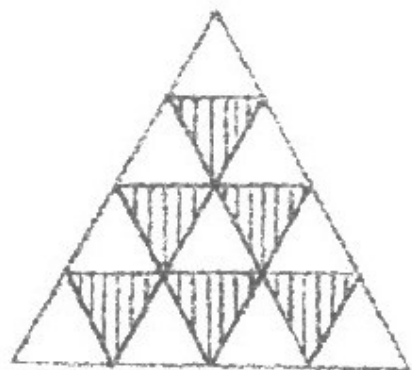
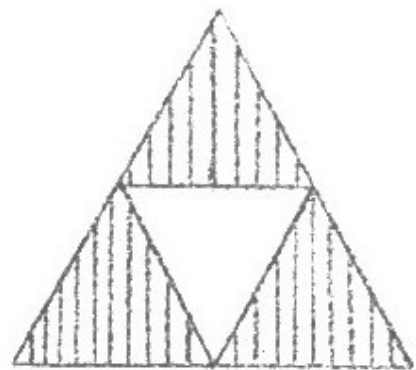

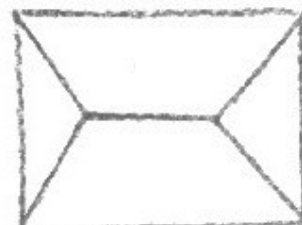
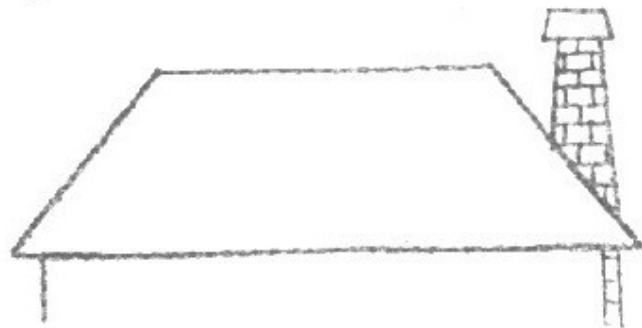
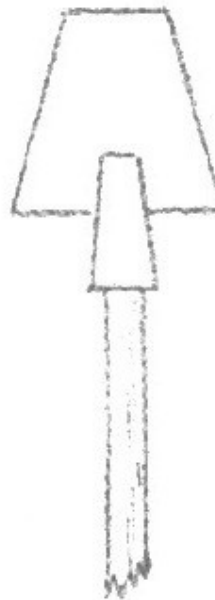
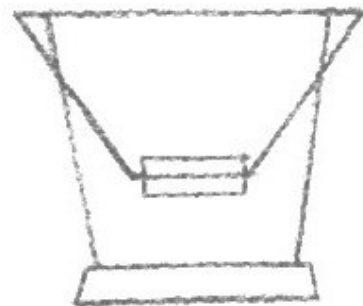
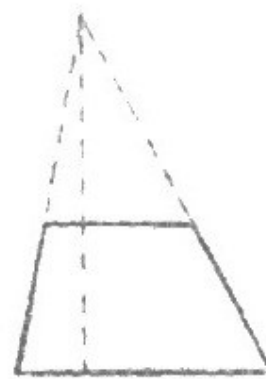
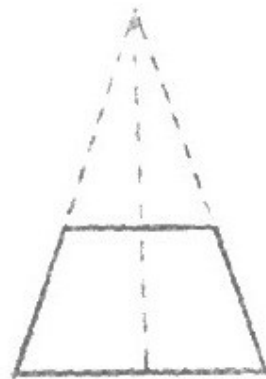
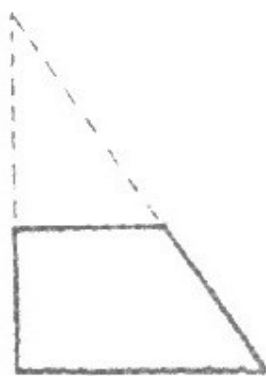
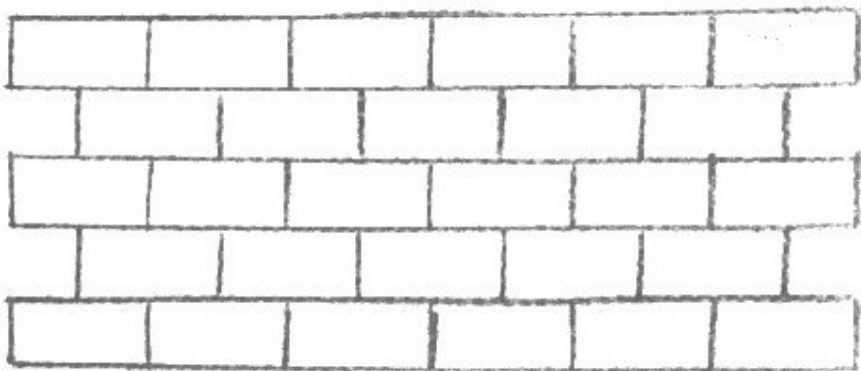
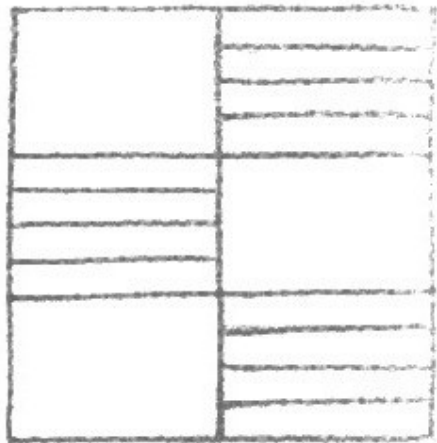
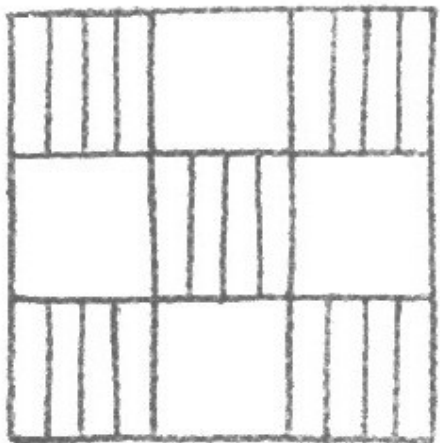
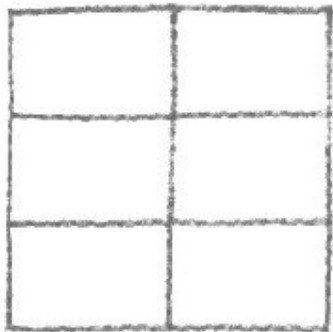
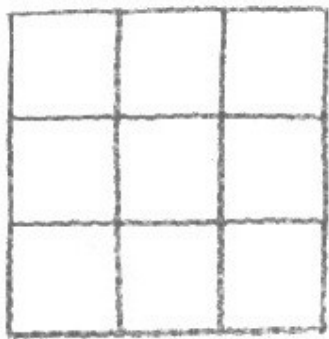

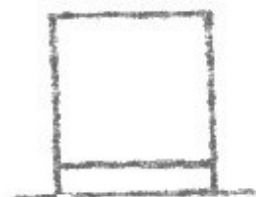
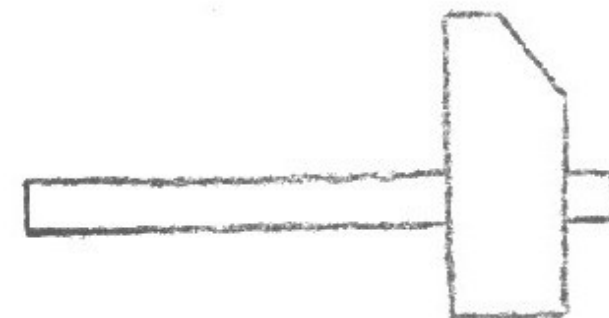
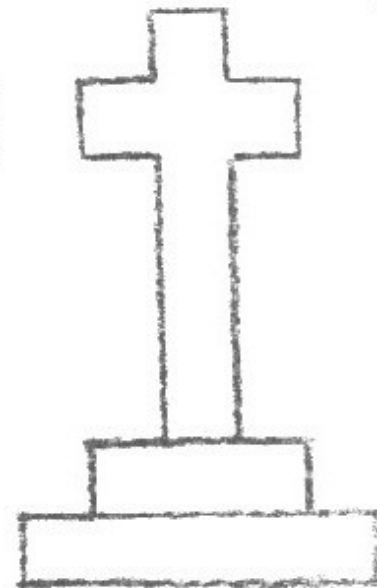
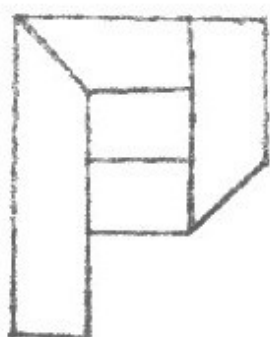
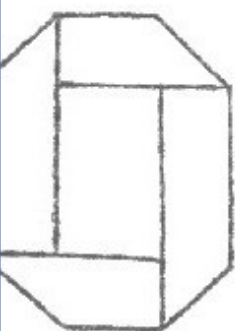
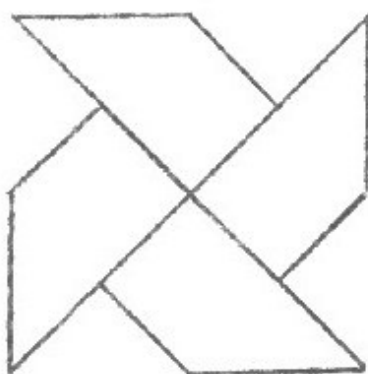
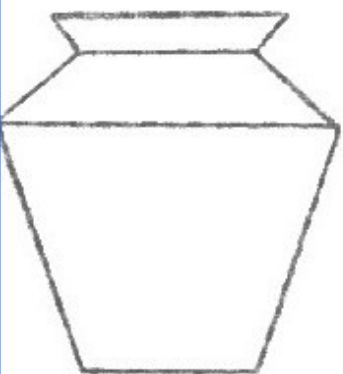
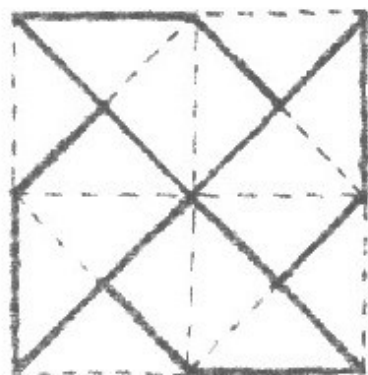
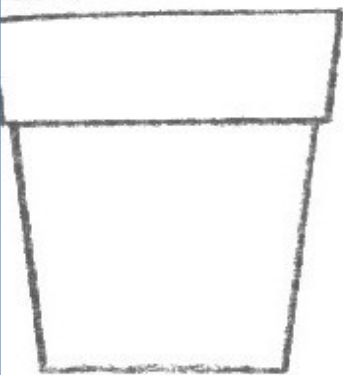

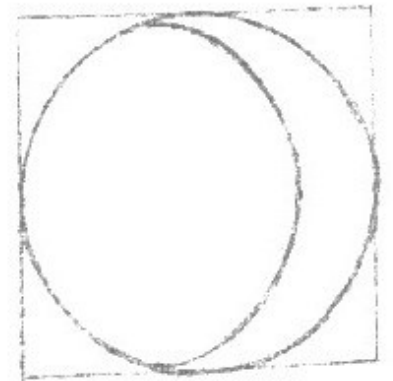
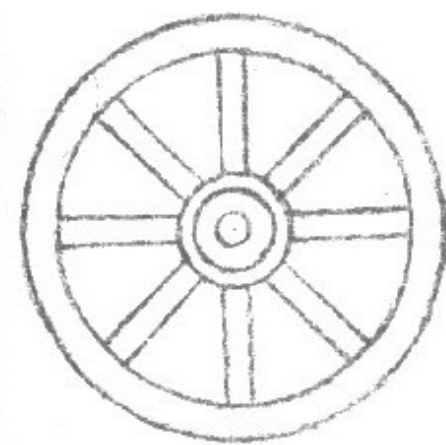
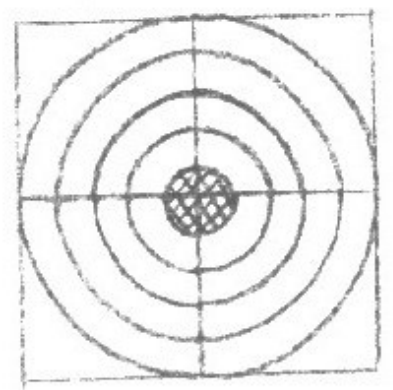
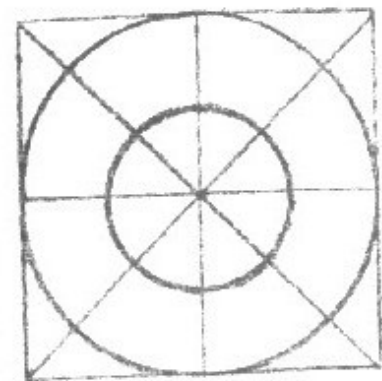
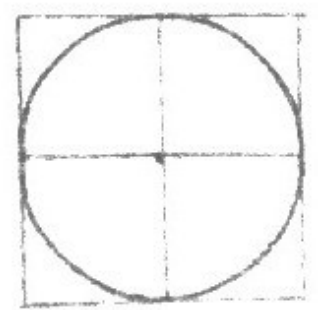
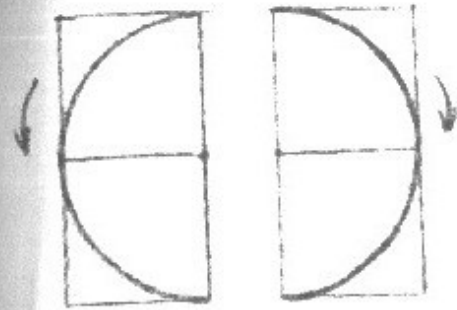
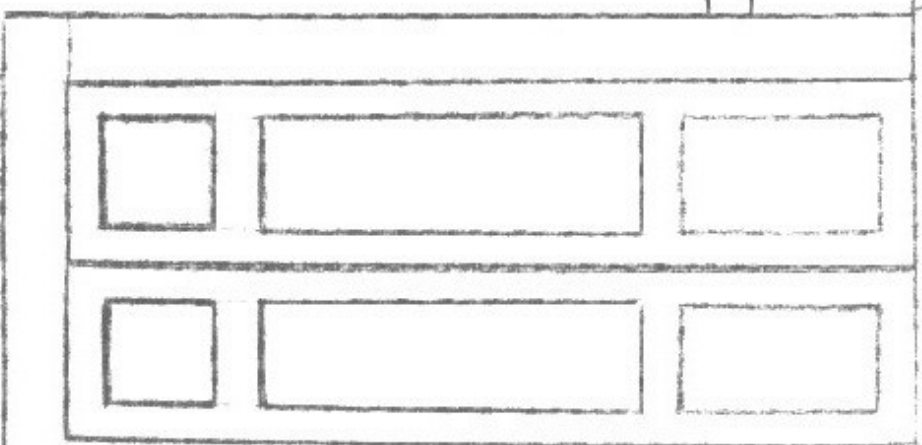
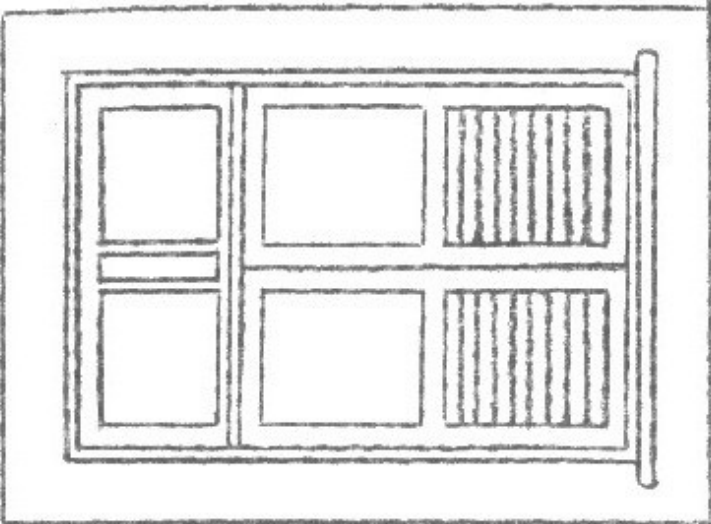

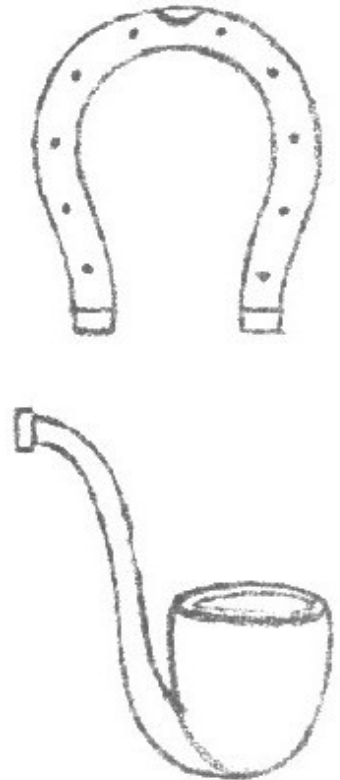
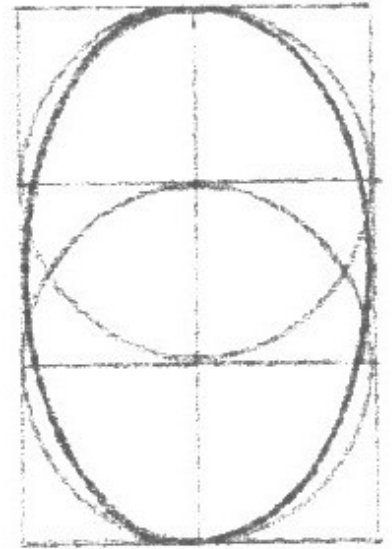
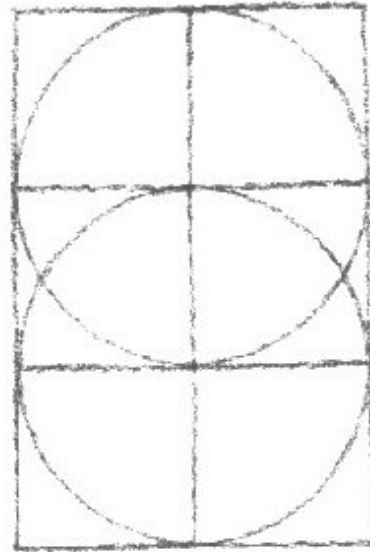
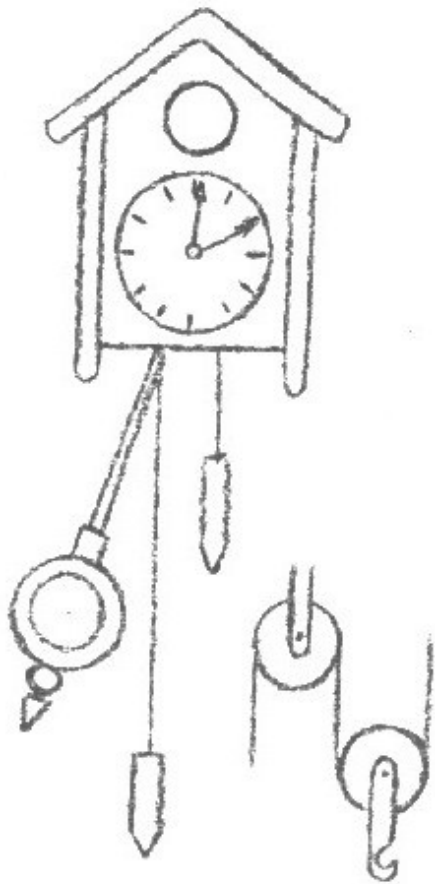
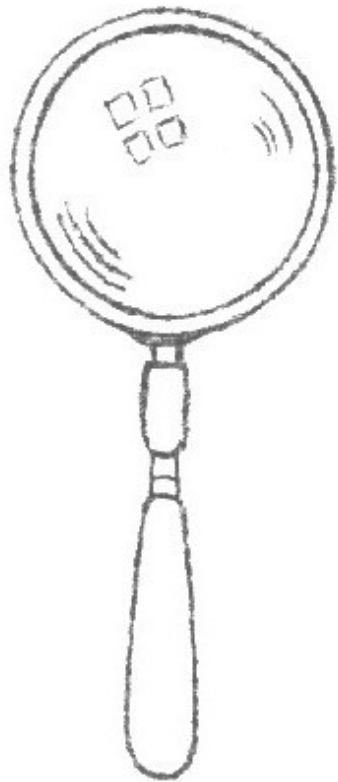
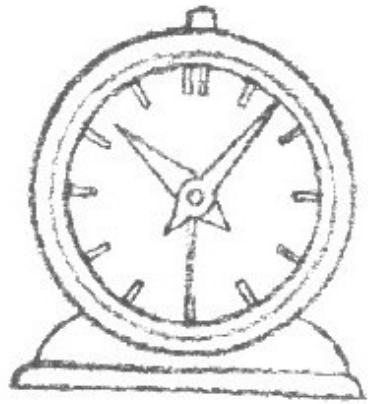
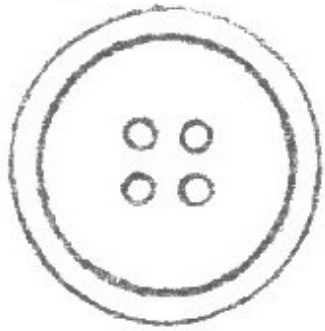

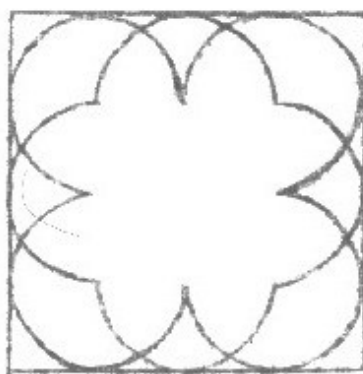
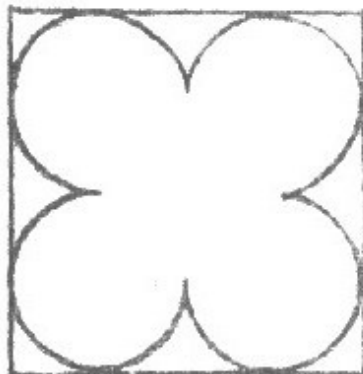
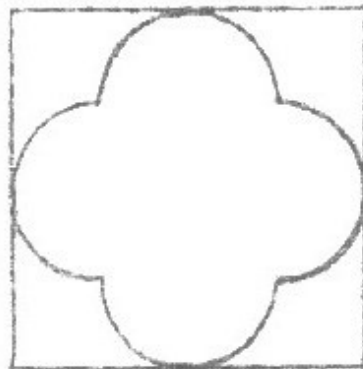
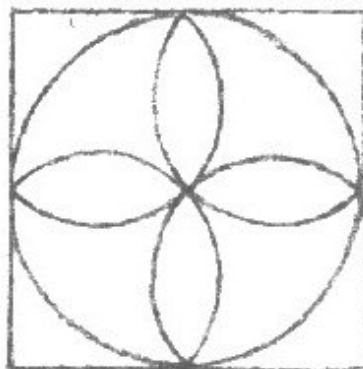
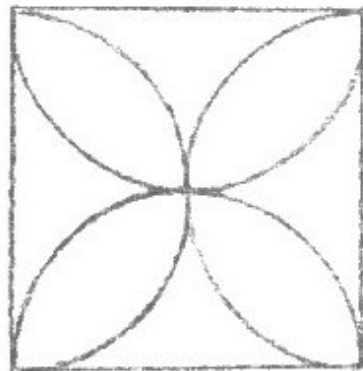
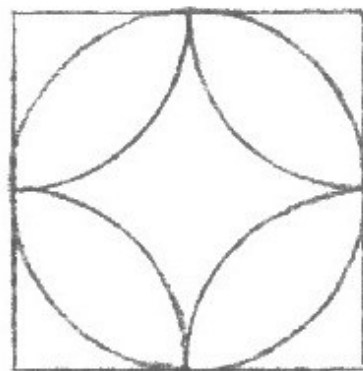
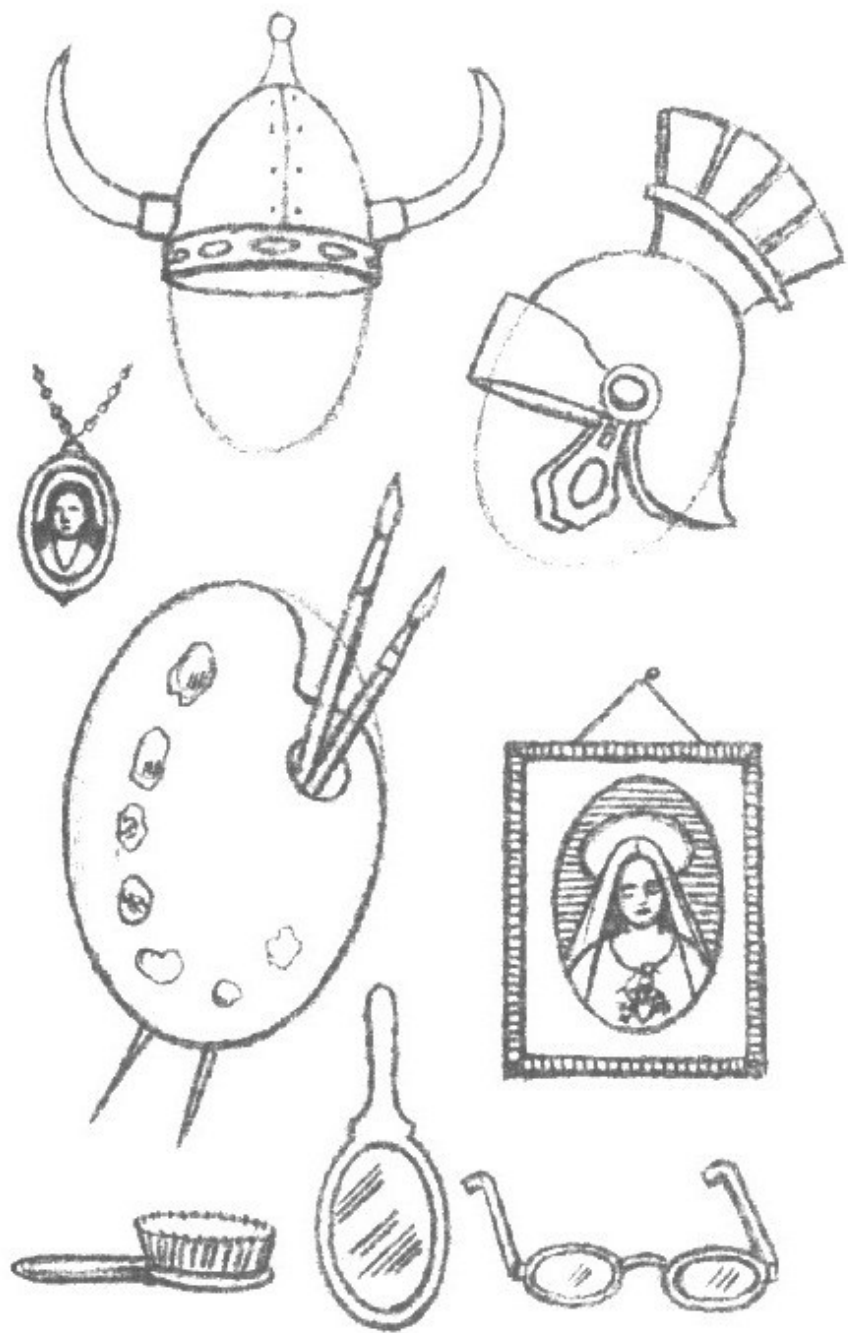

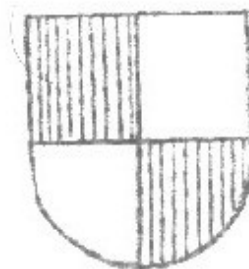
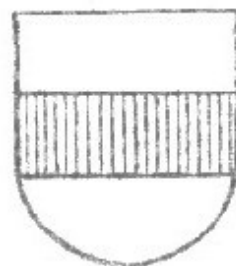
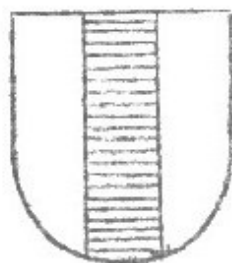
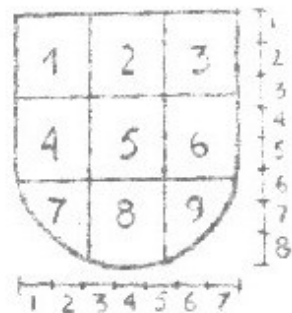
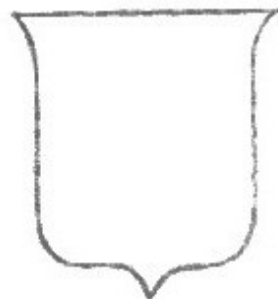
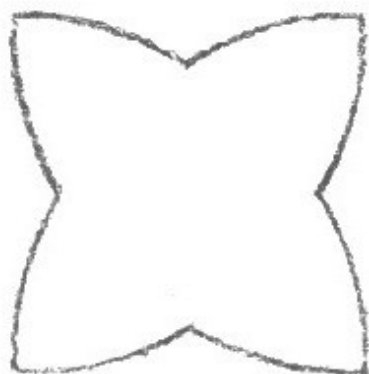
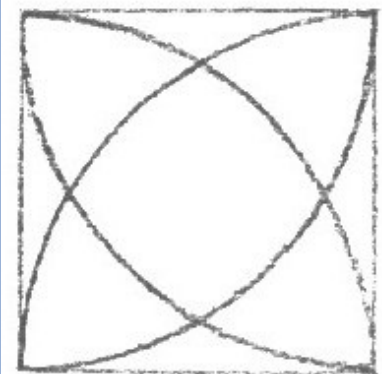
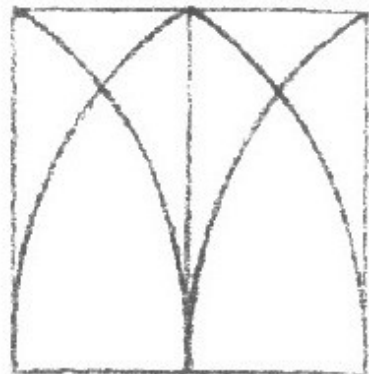
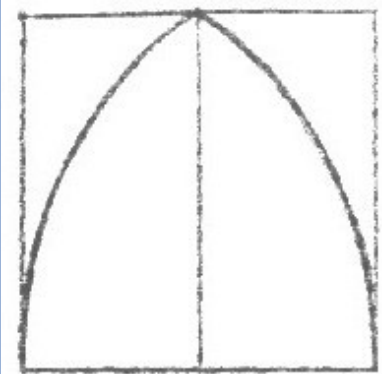

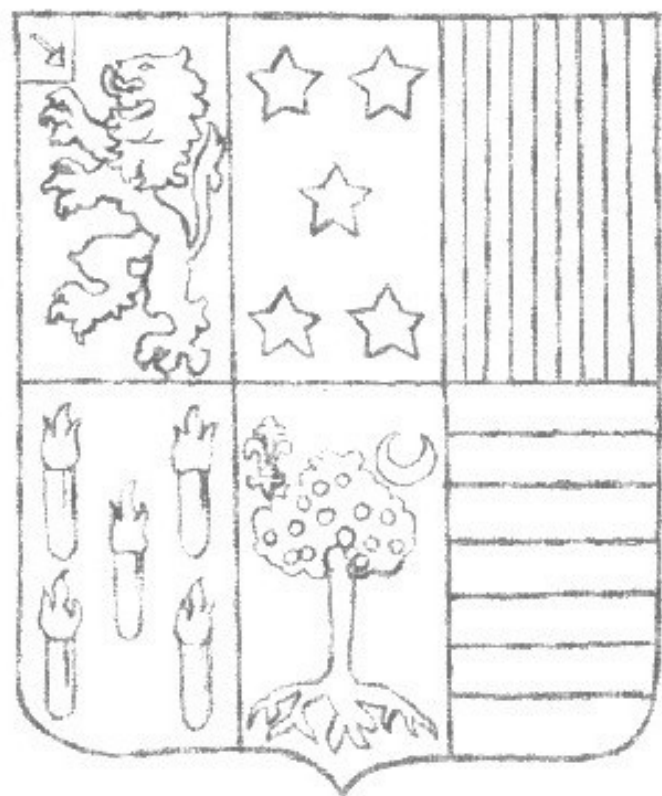
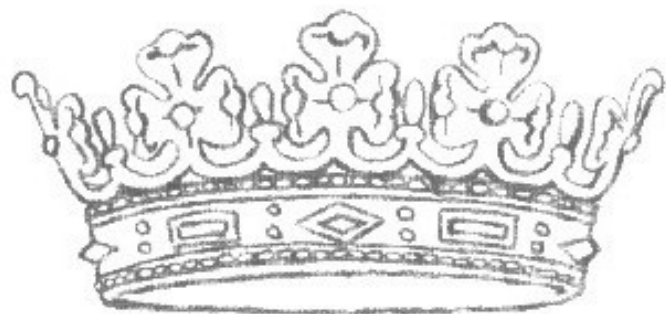

CAPÍTULO III
*
SÓLIDOS GEOMÉTRICOS

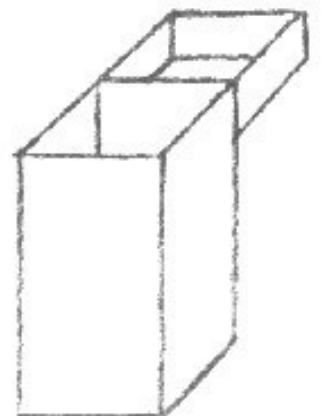
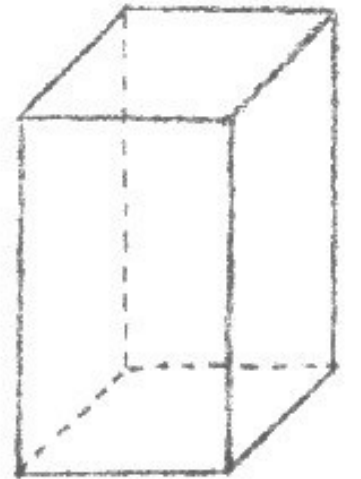
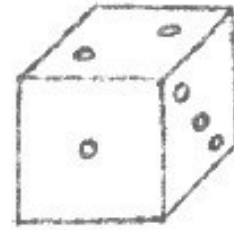
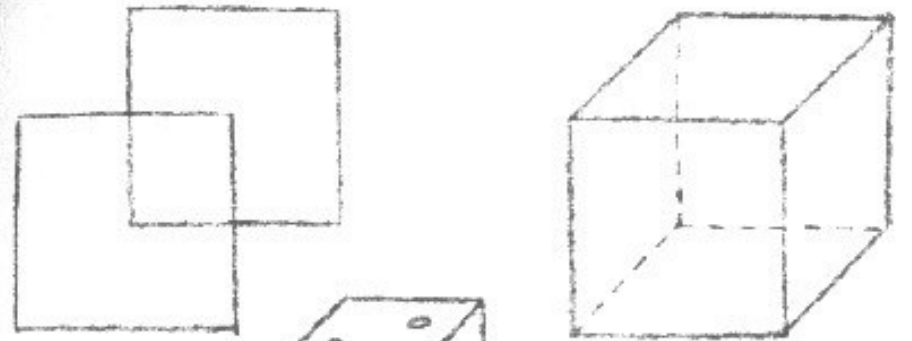

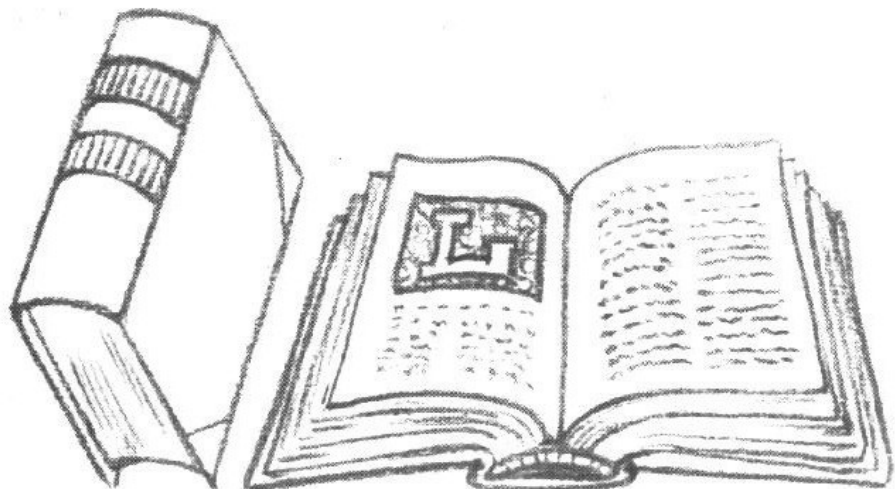
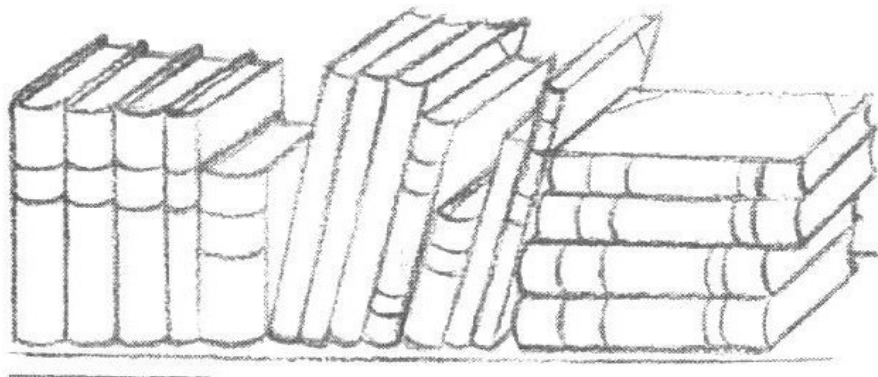
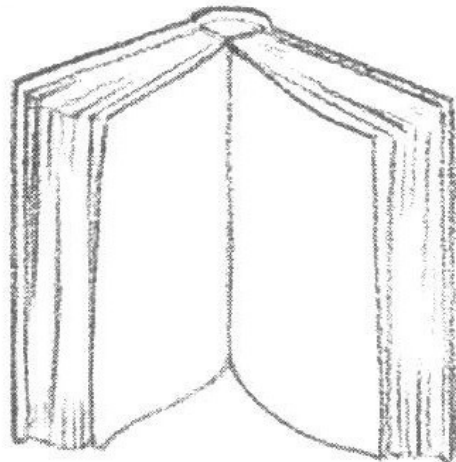
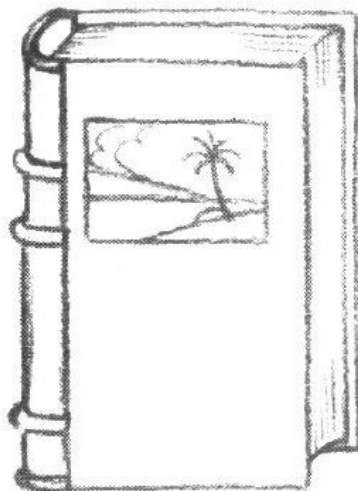
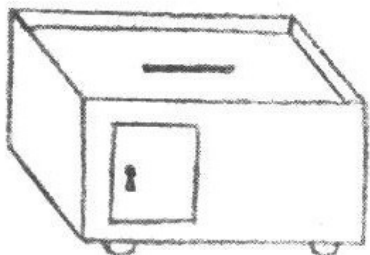
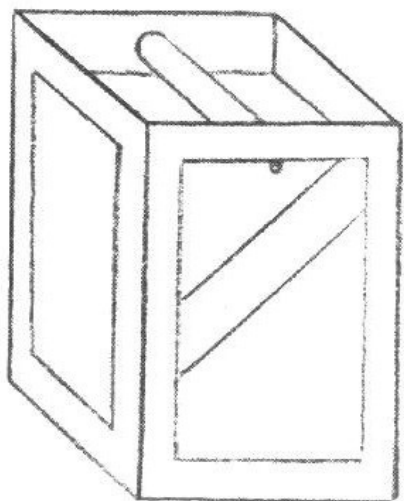
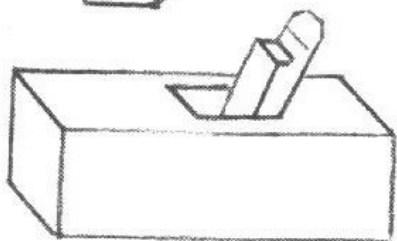
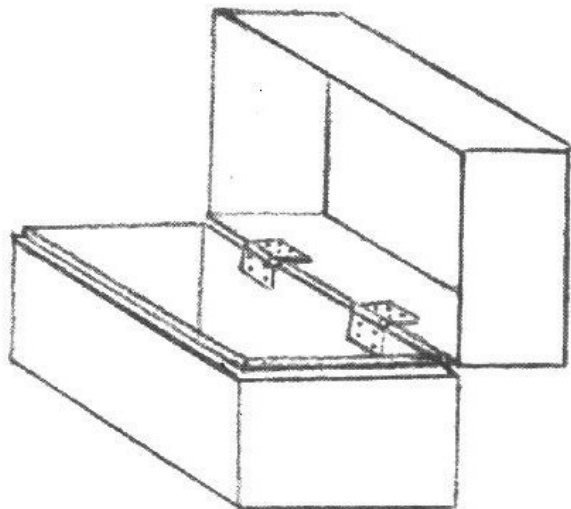
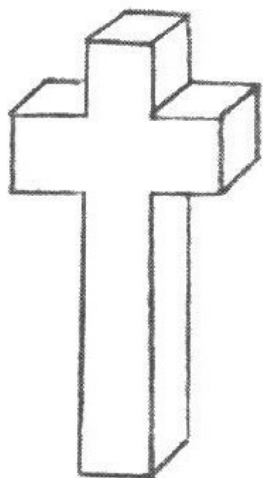
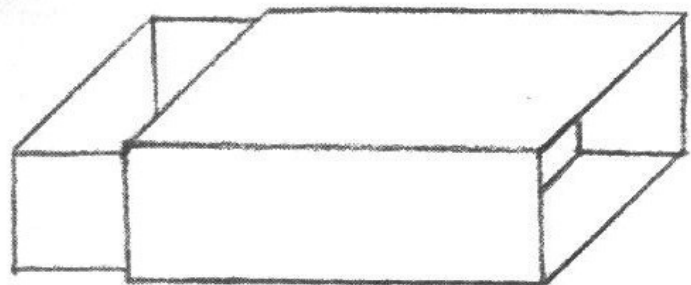

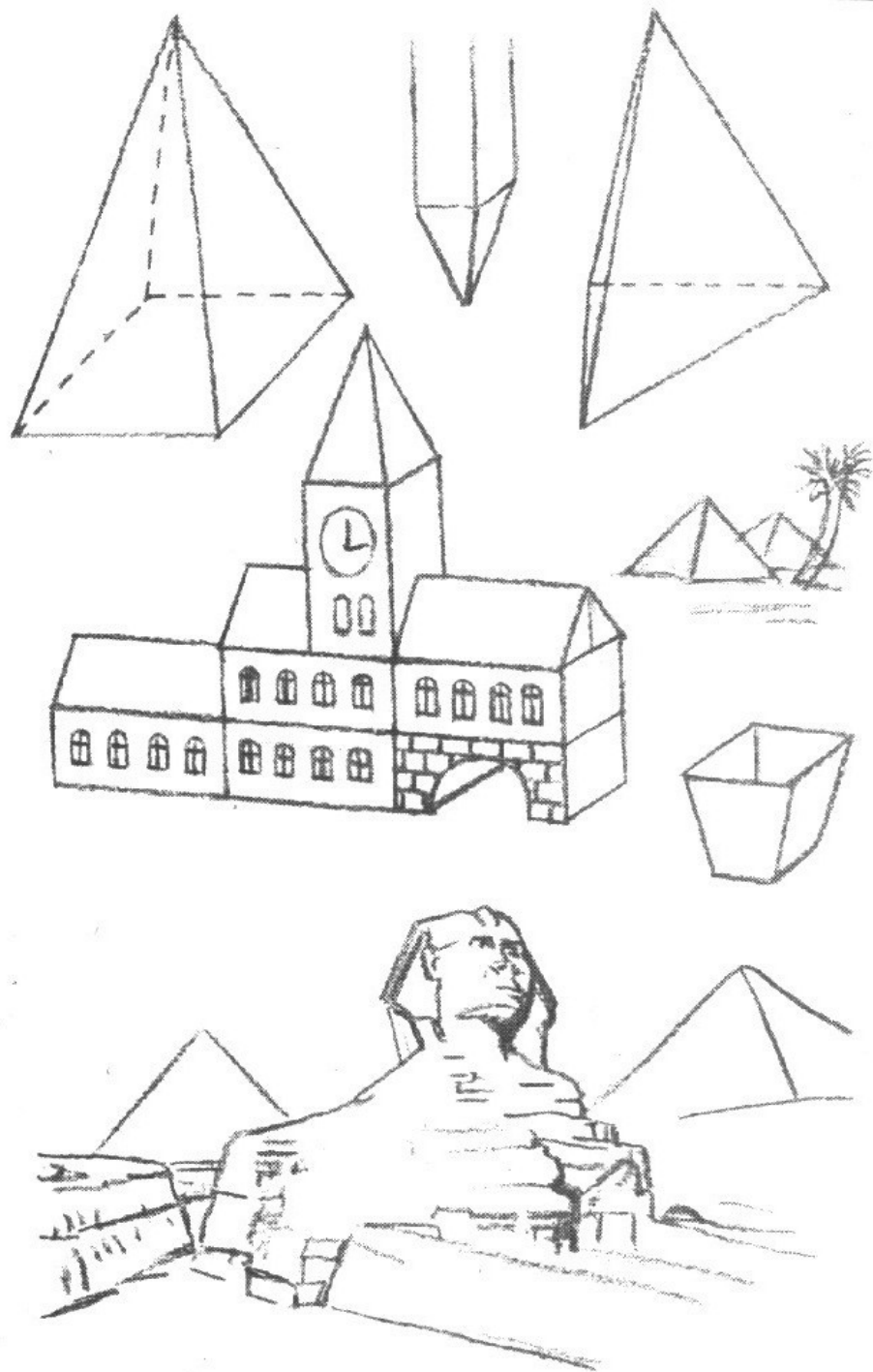
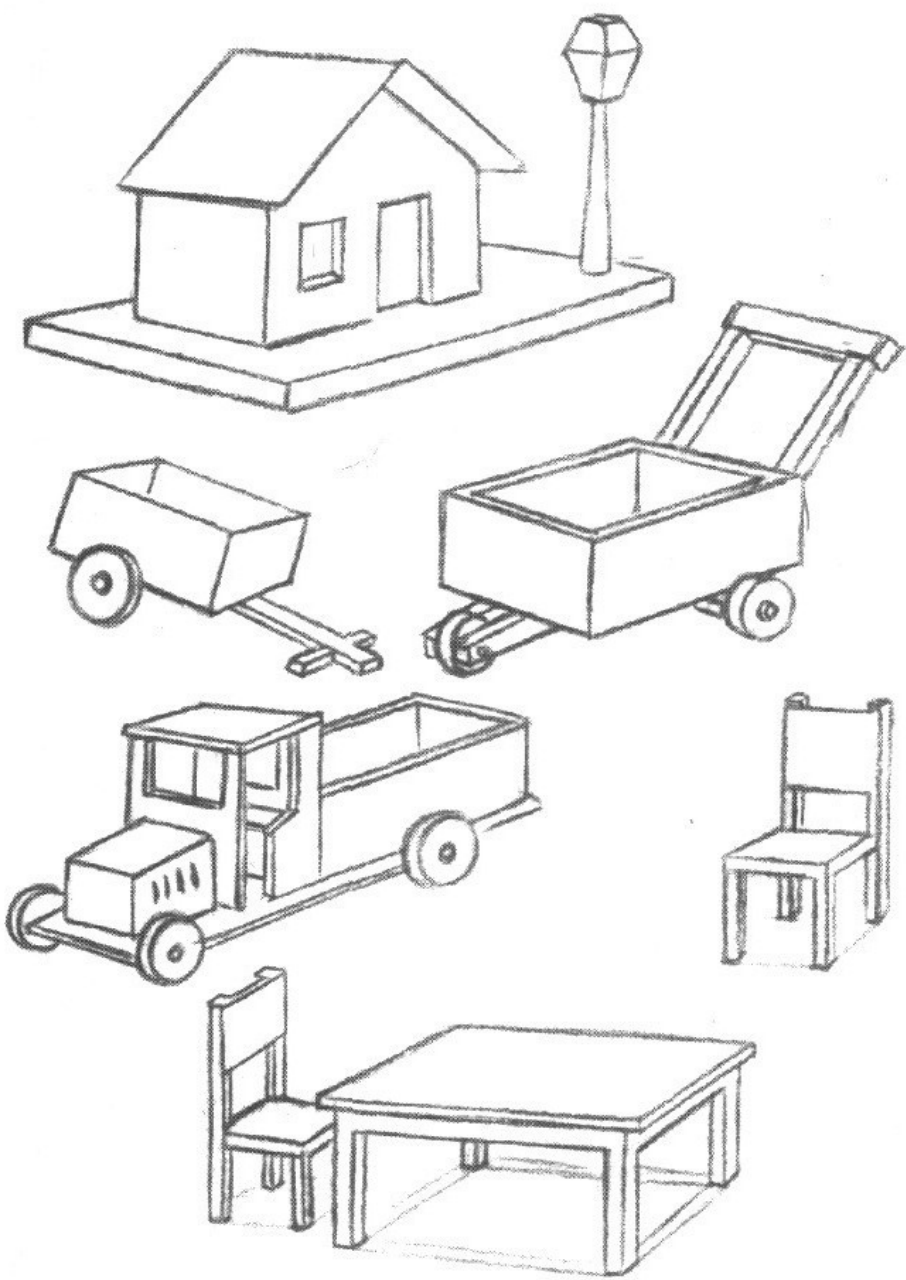

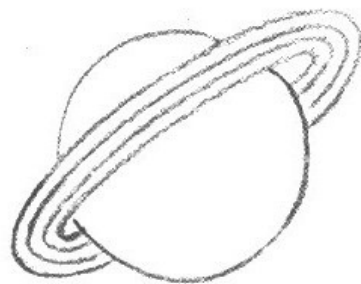
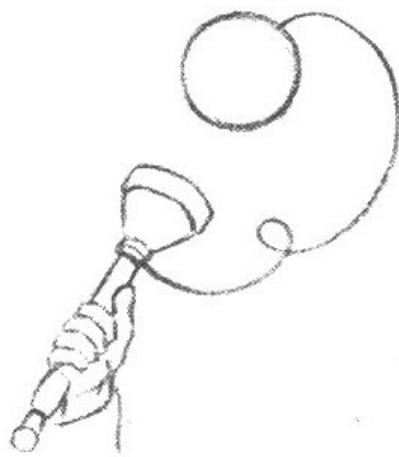
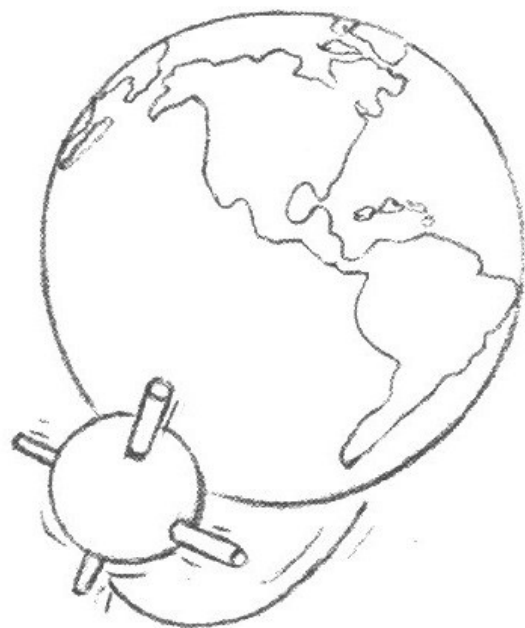
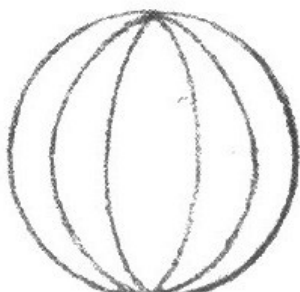
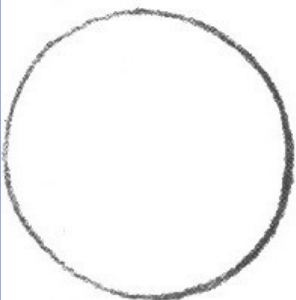
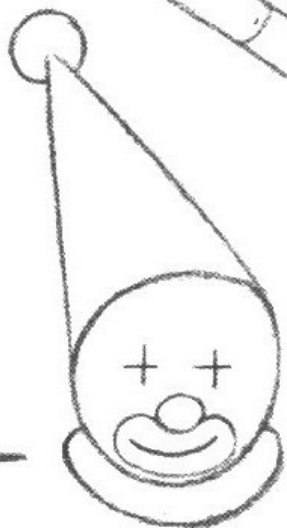
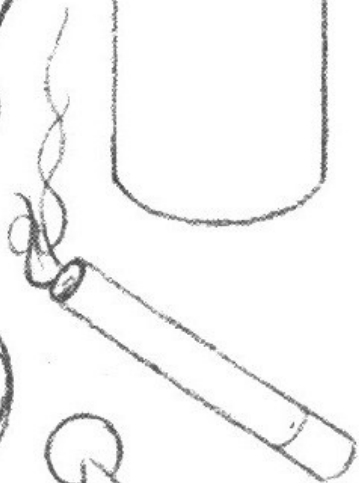
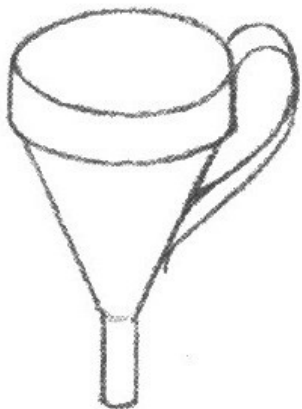
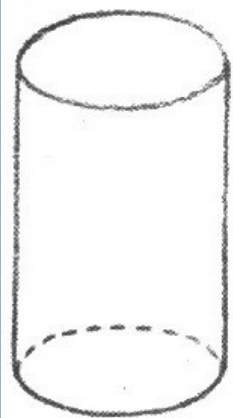

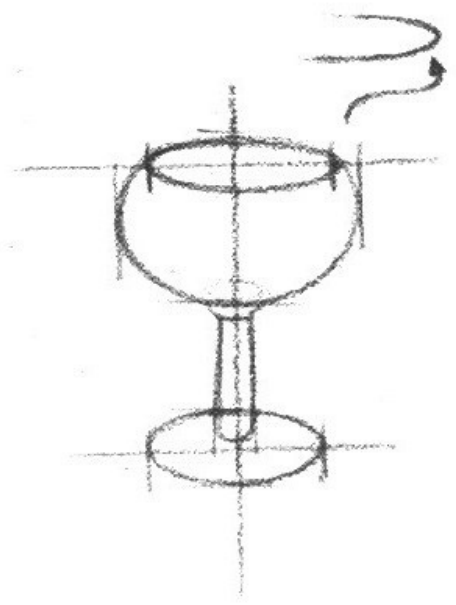
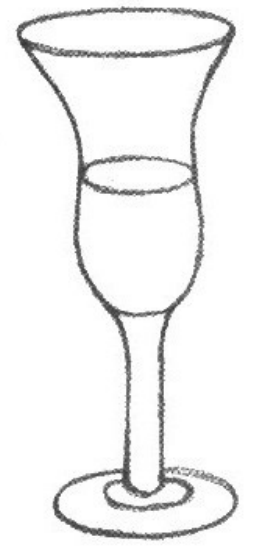
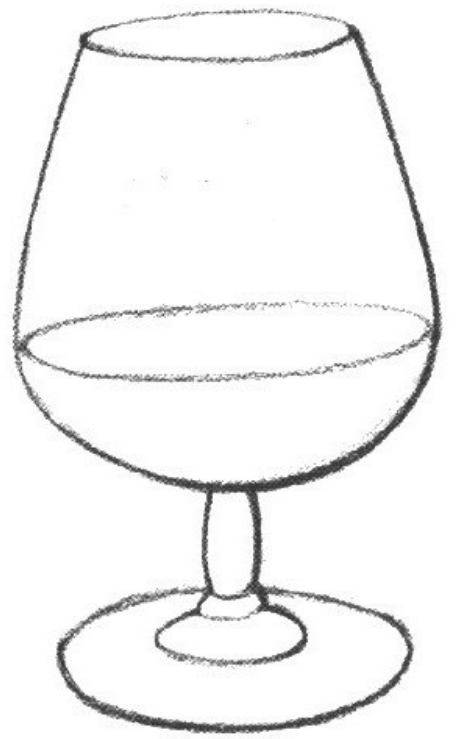
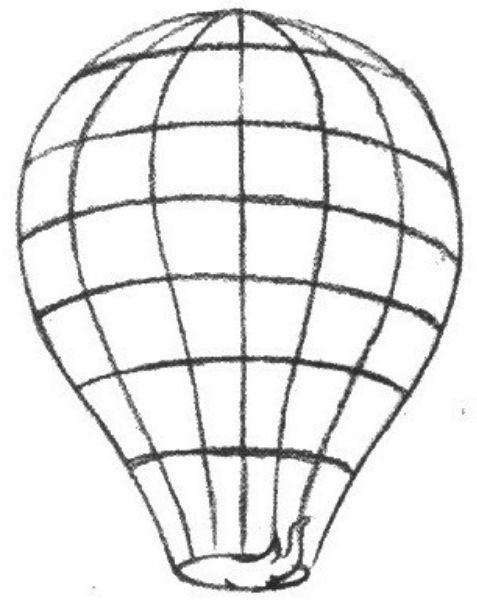
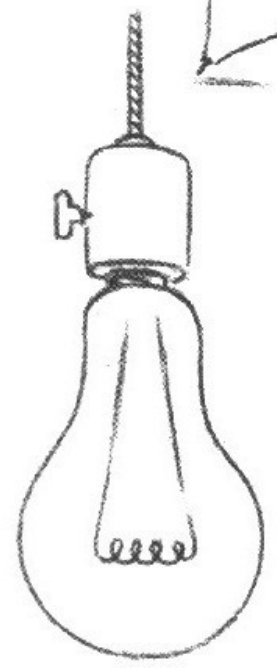
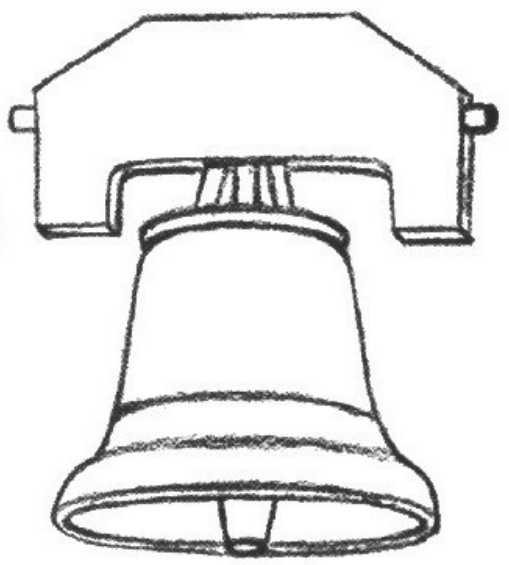

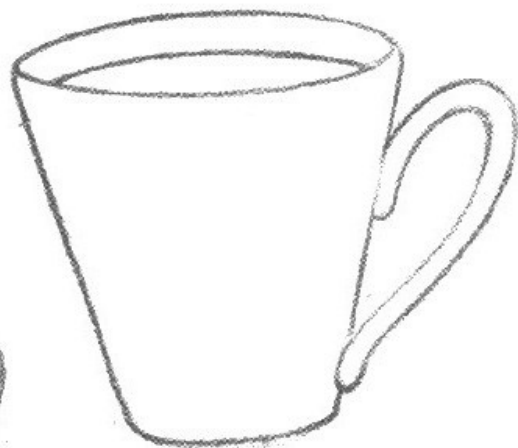
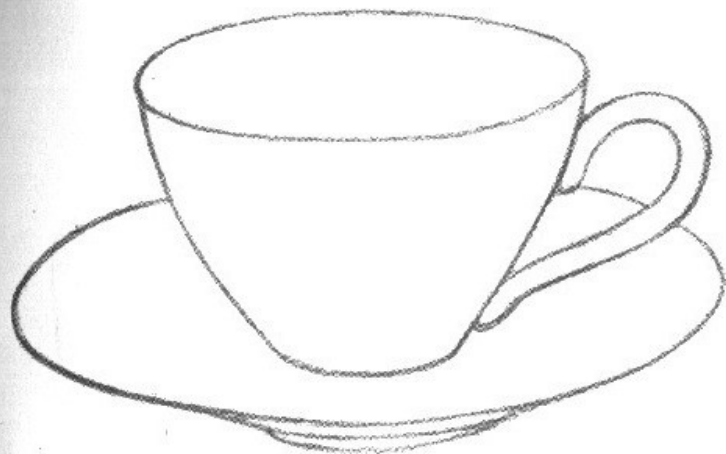
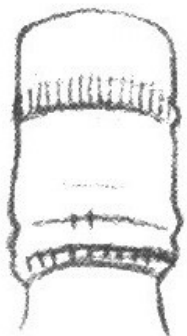
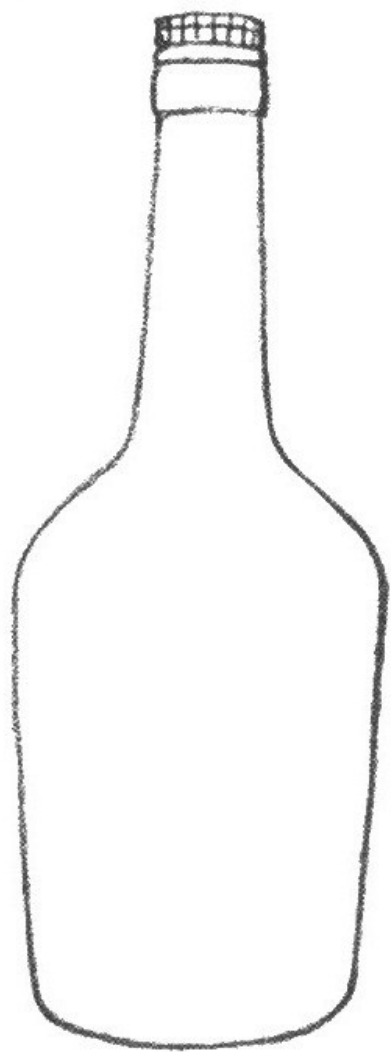

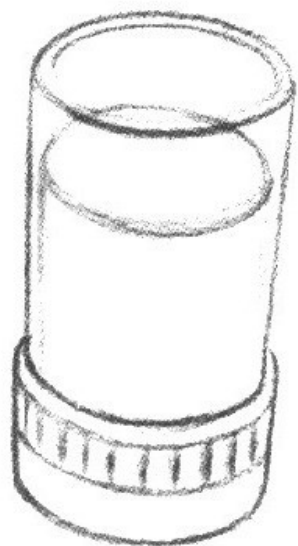
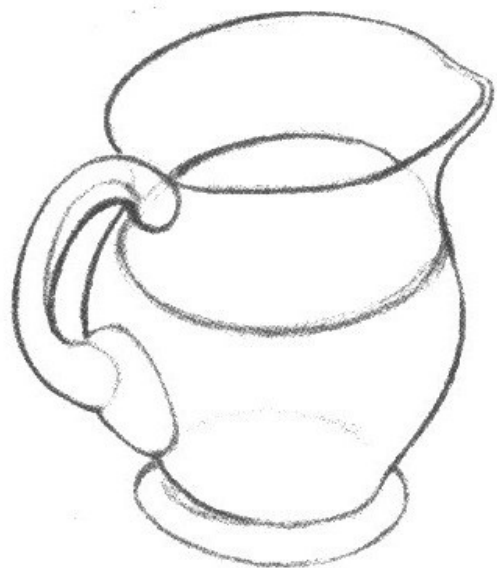

CAPÍTULO IV
*
VEGETAIS

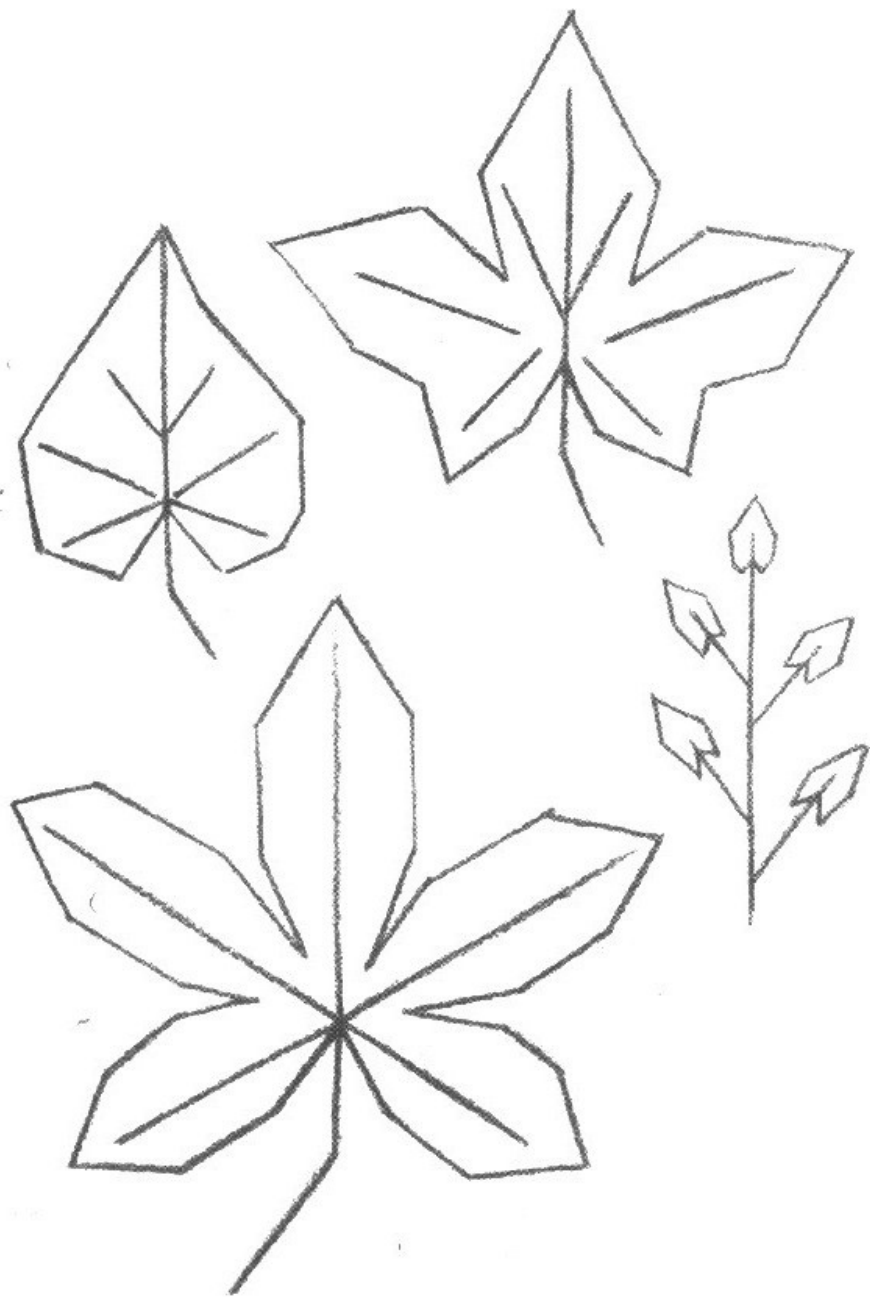

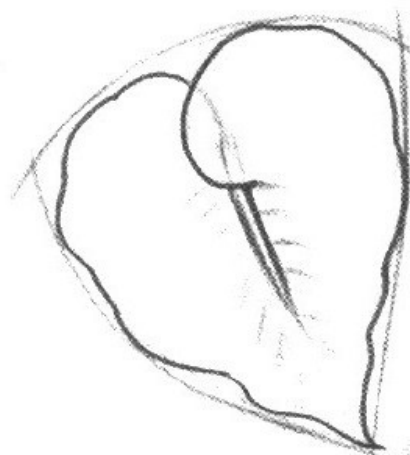
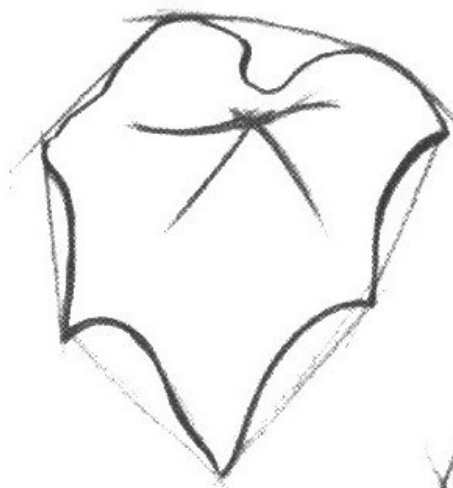
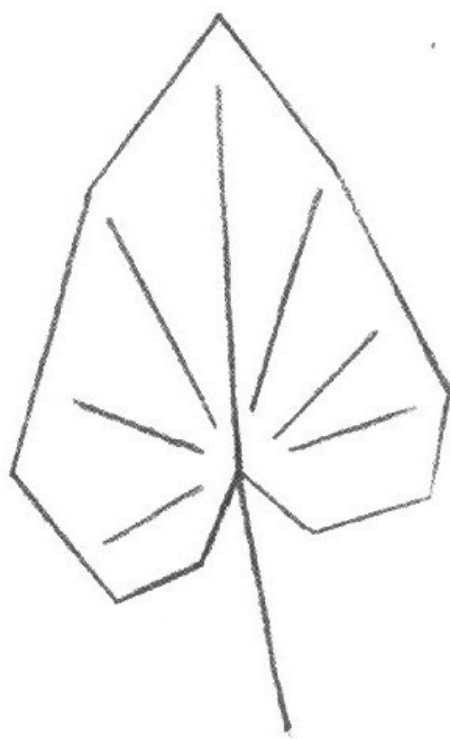
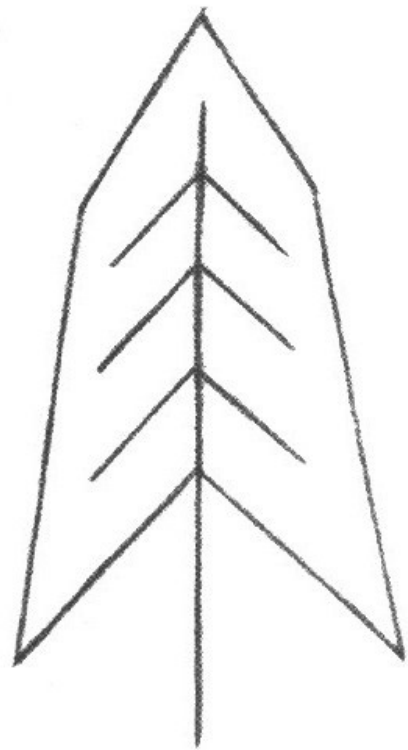
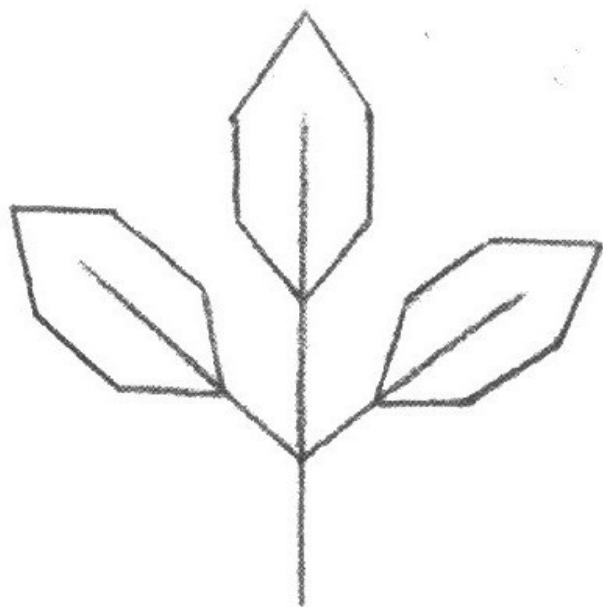

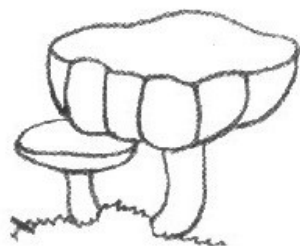
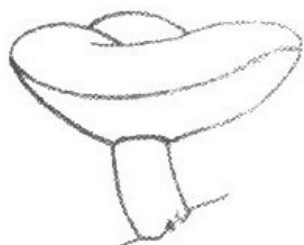
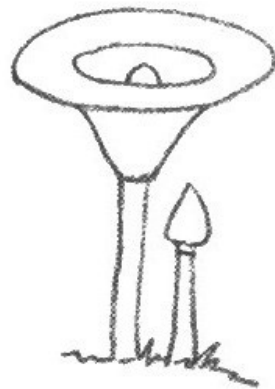
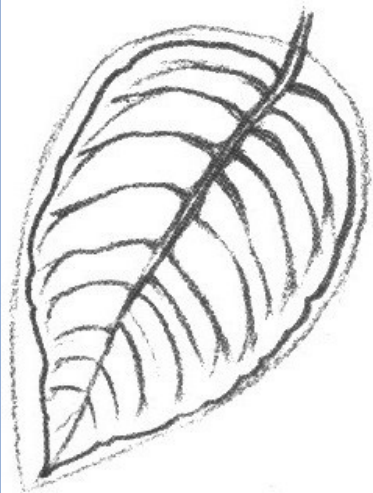
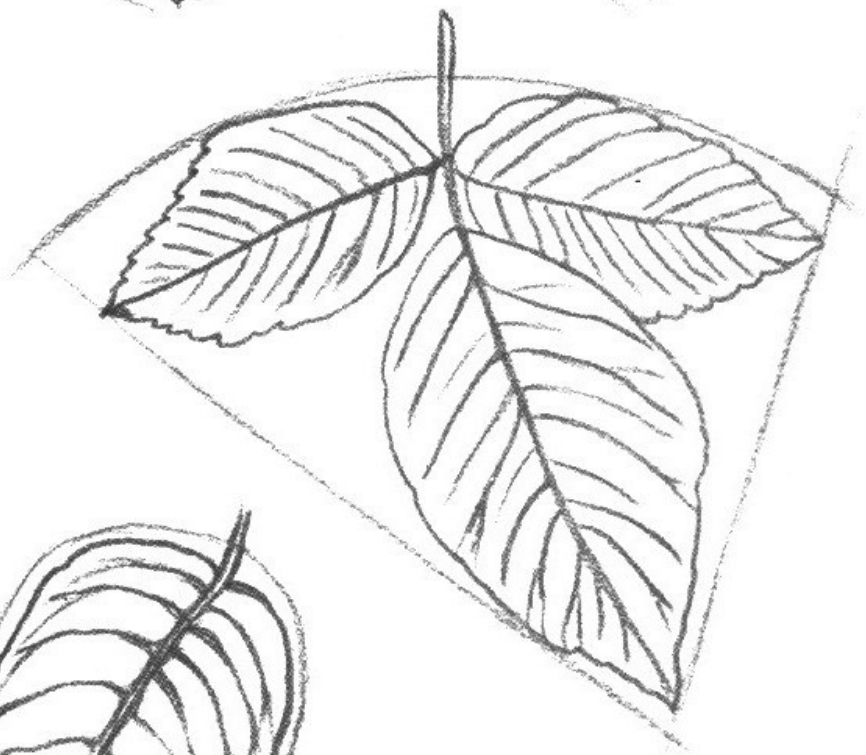
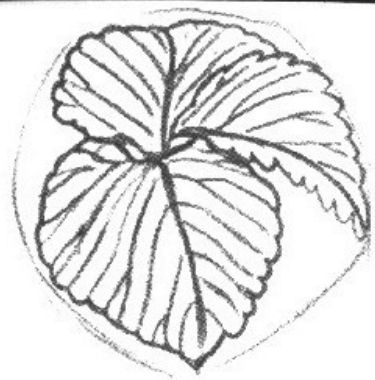

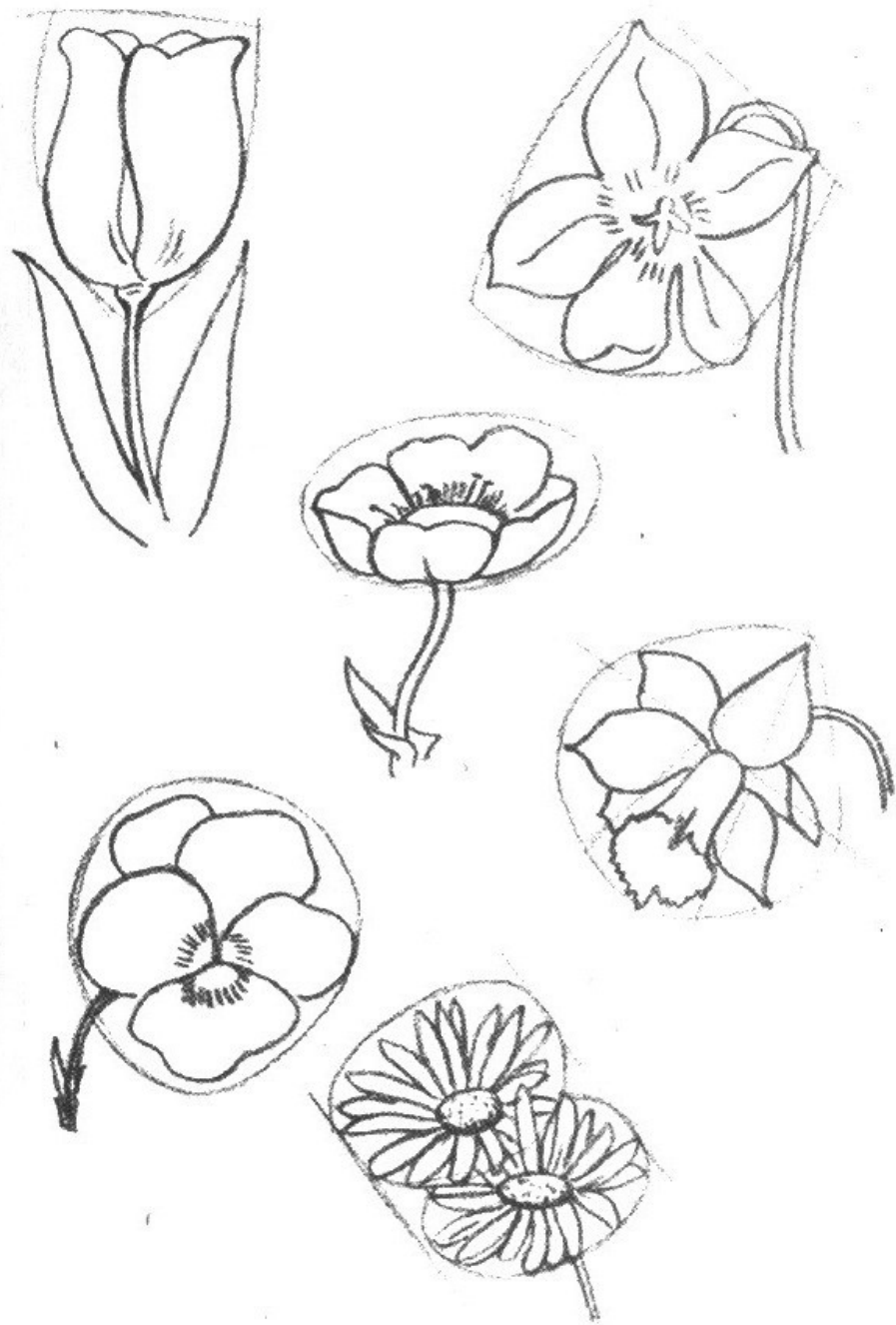
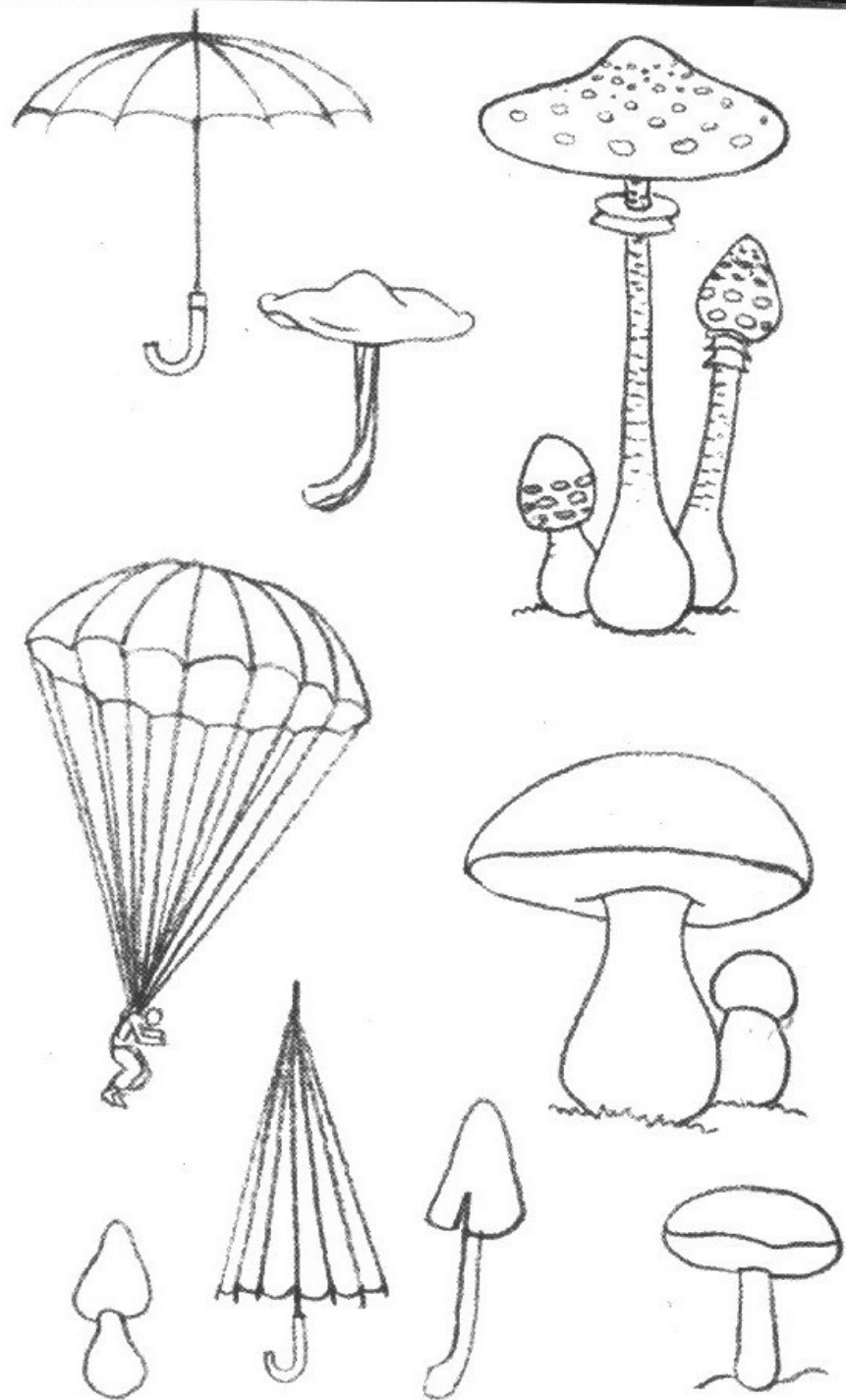

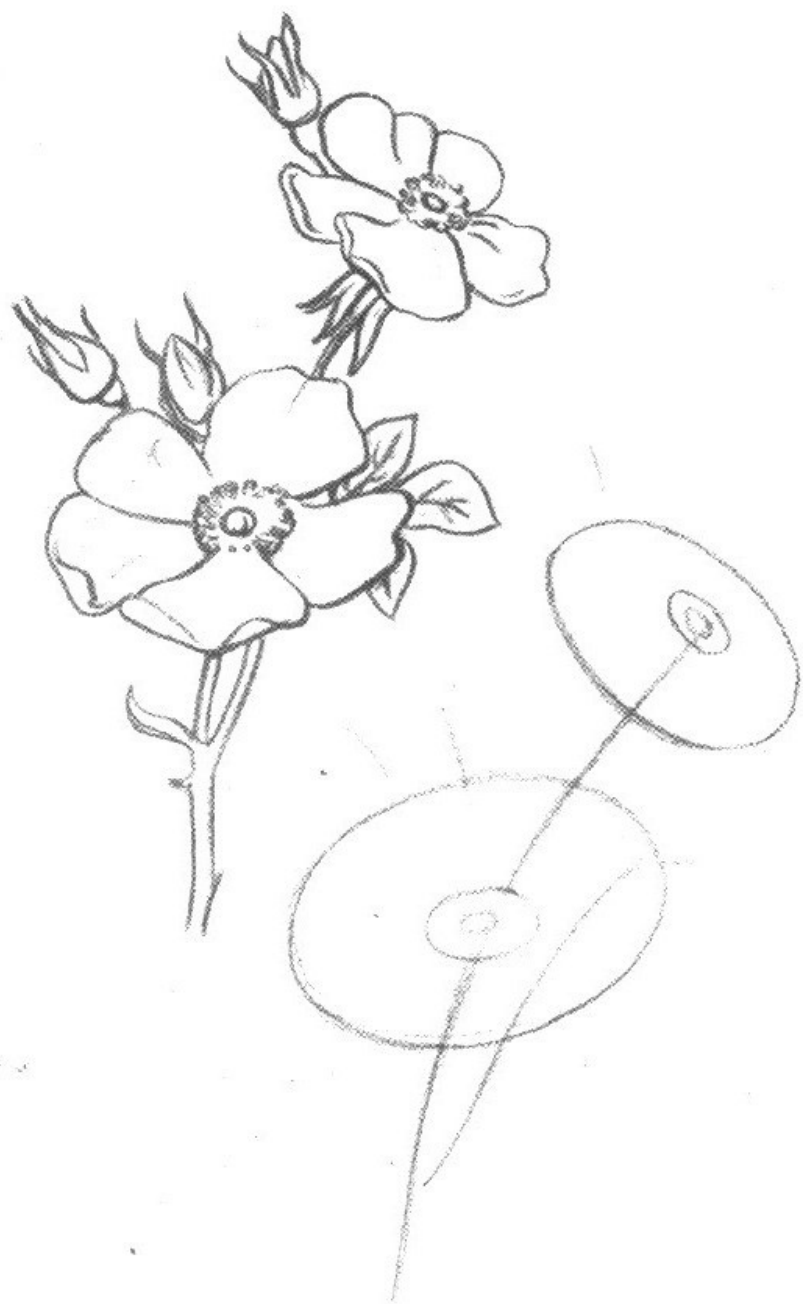
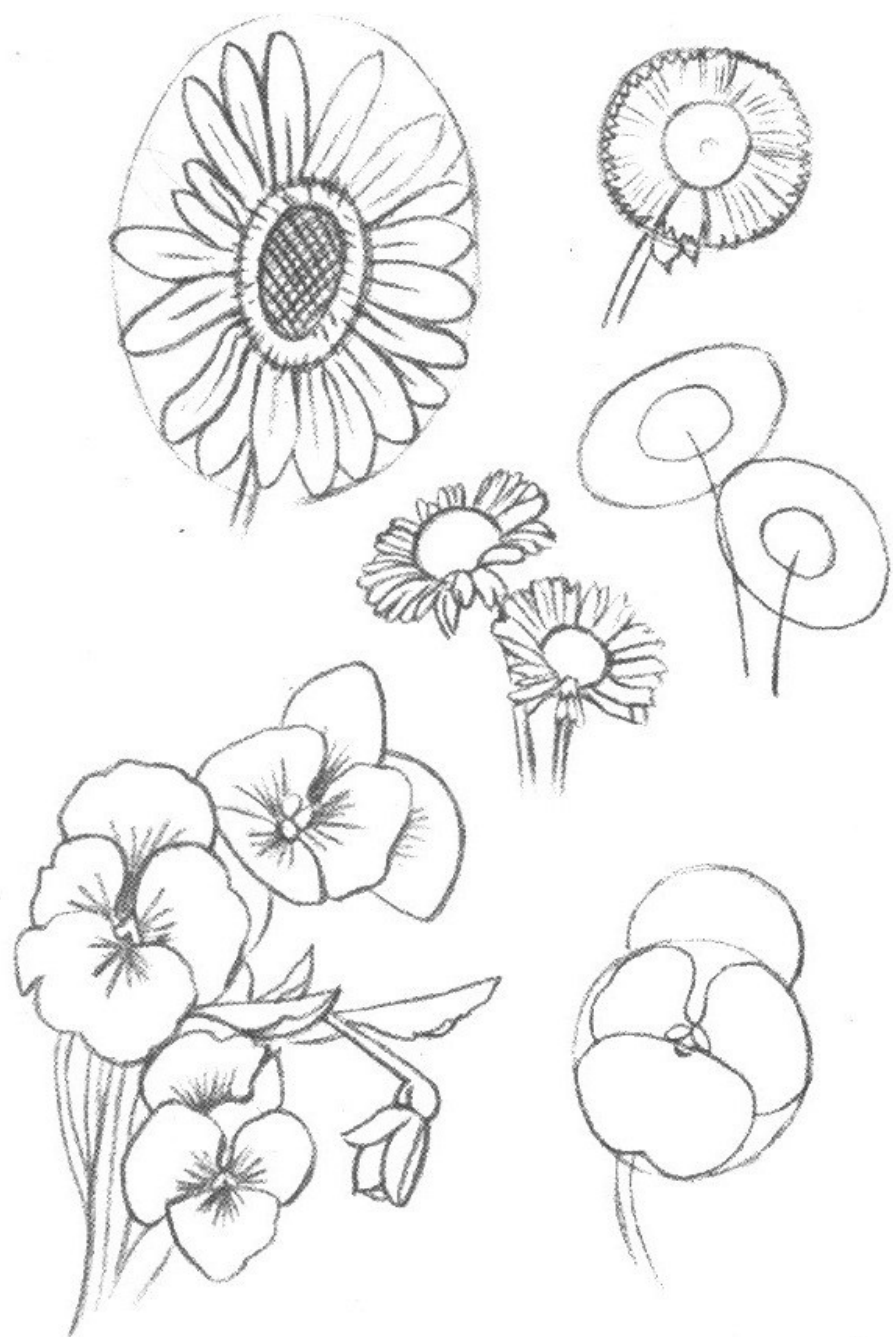

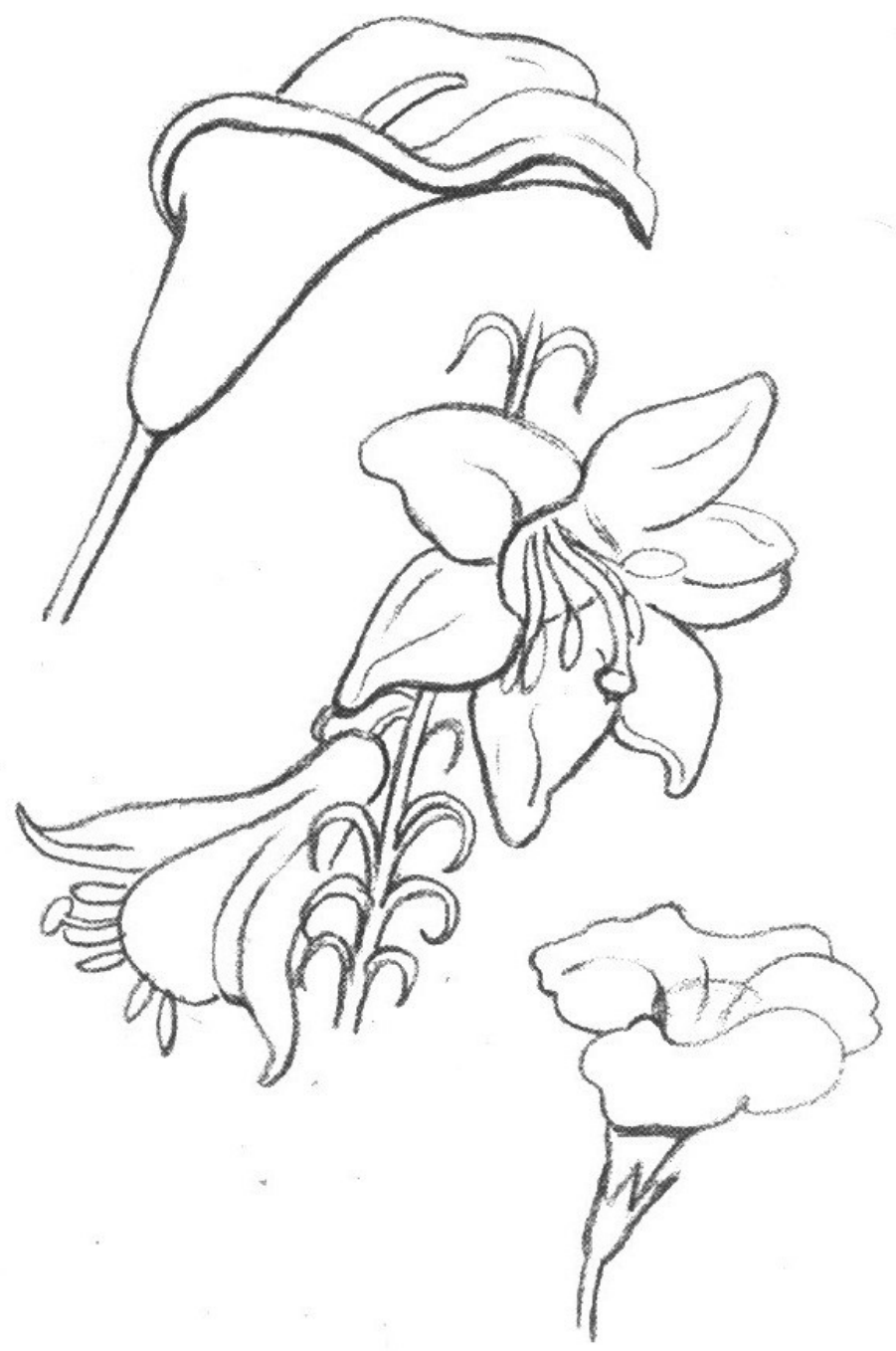
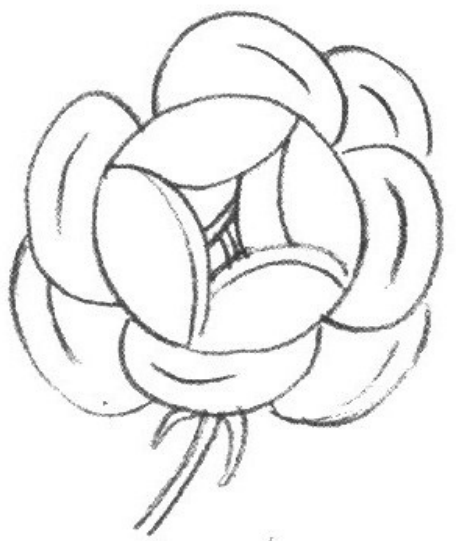
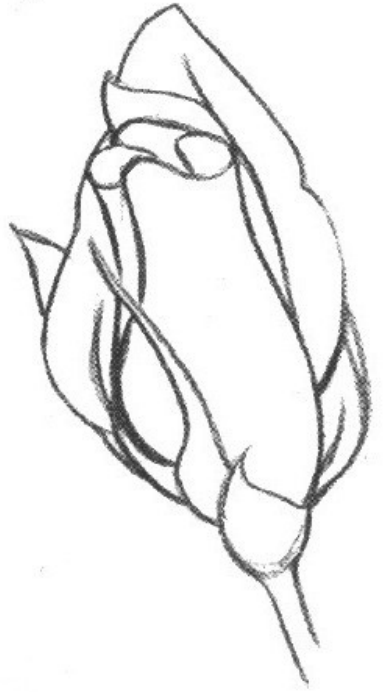

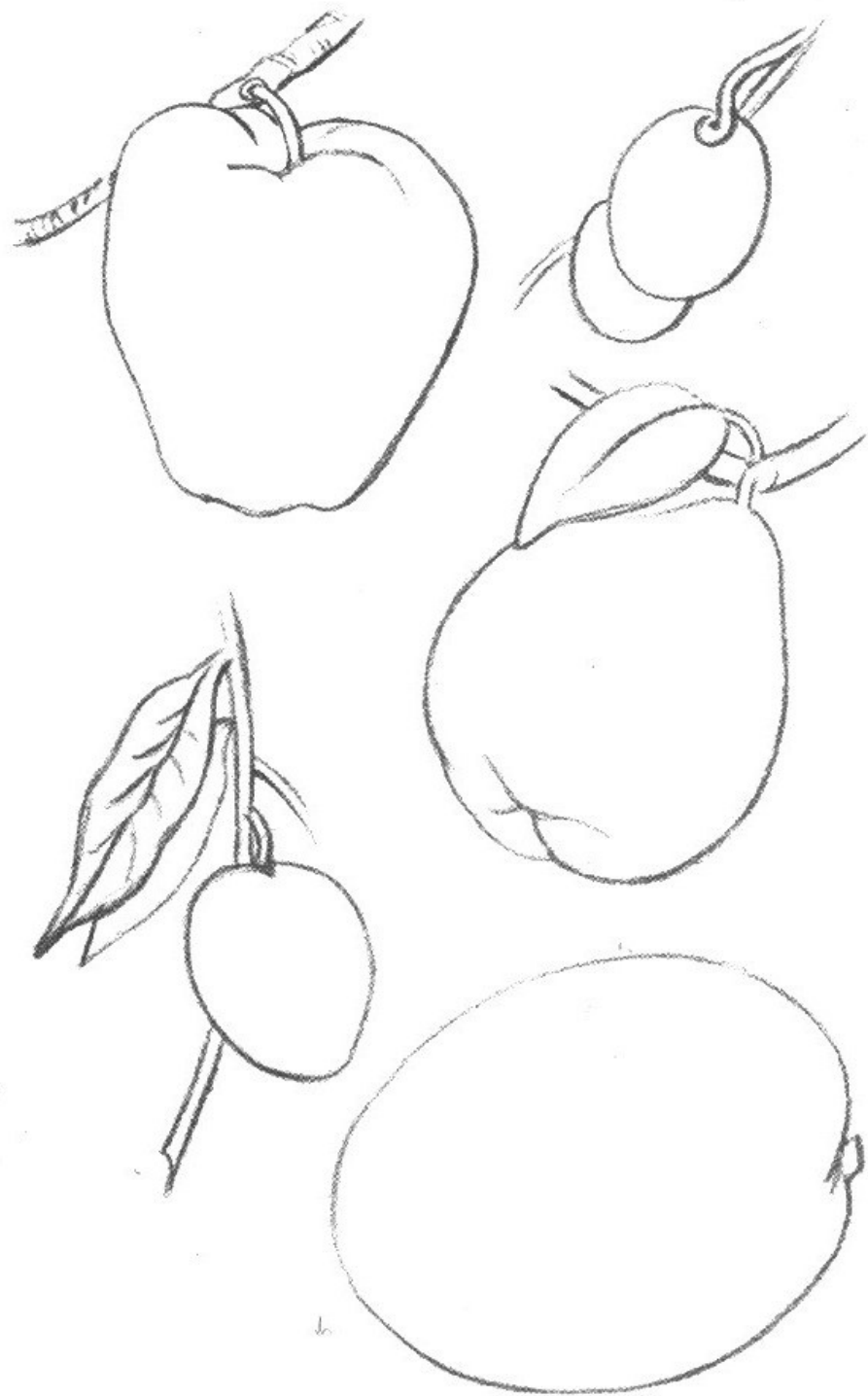
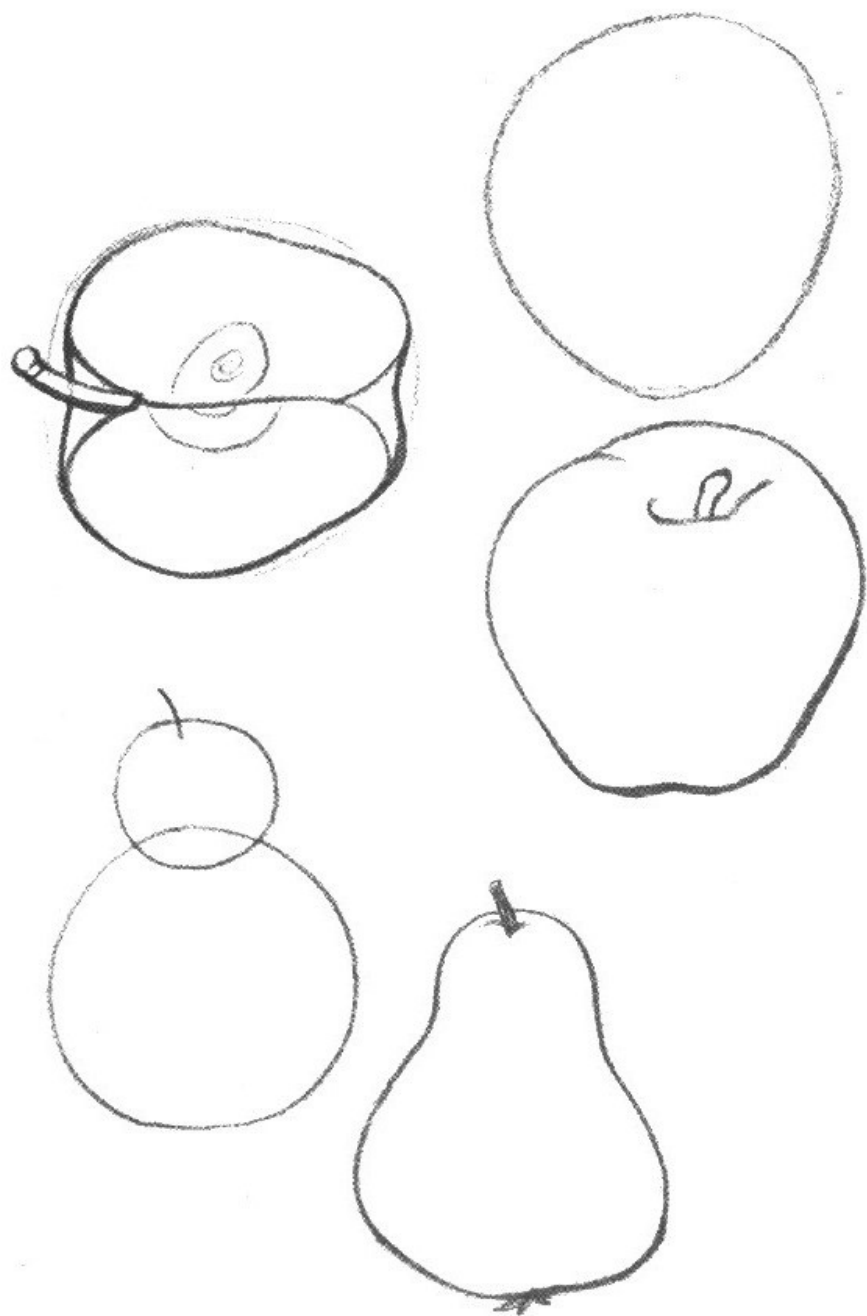

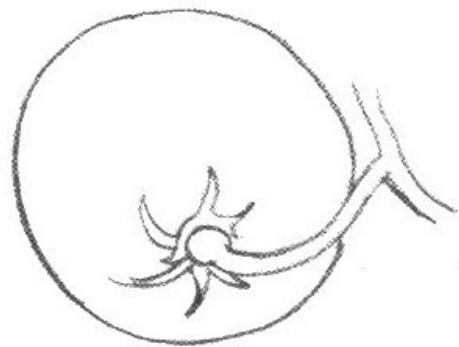
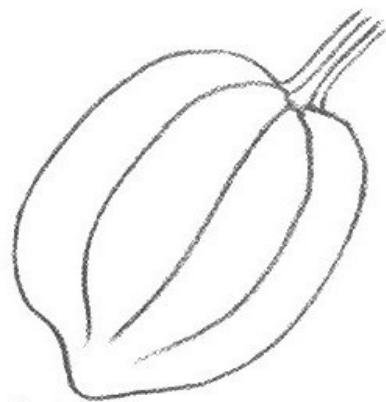
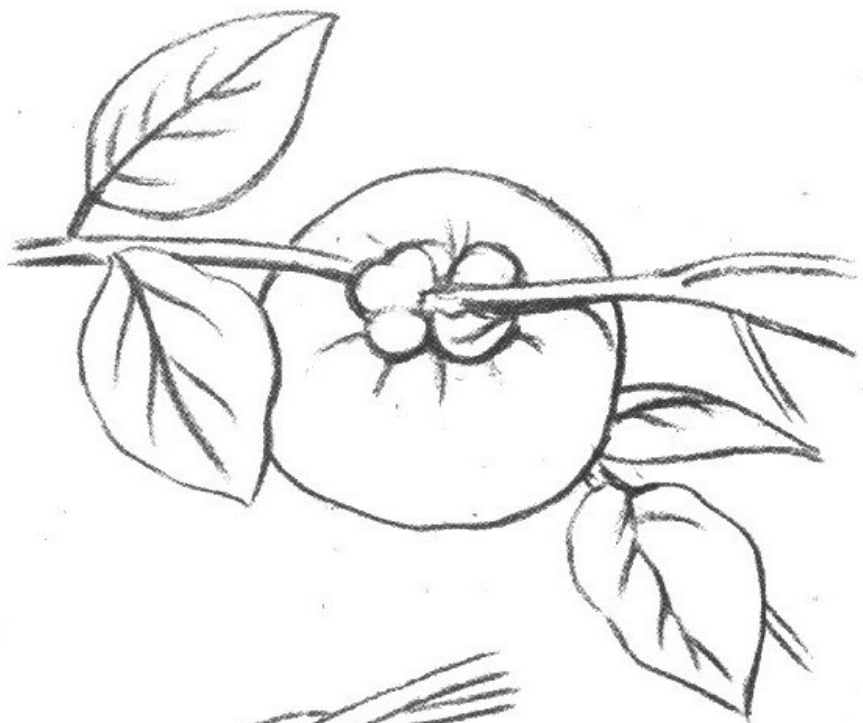

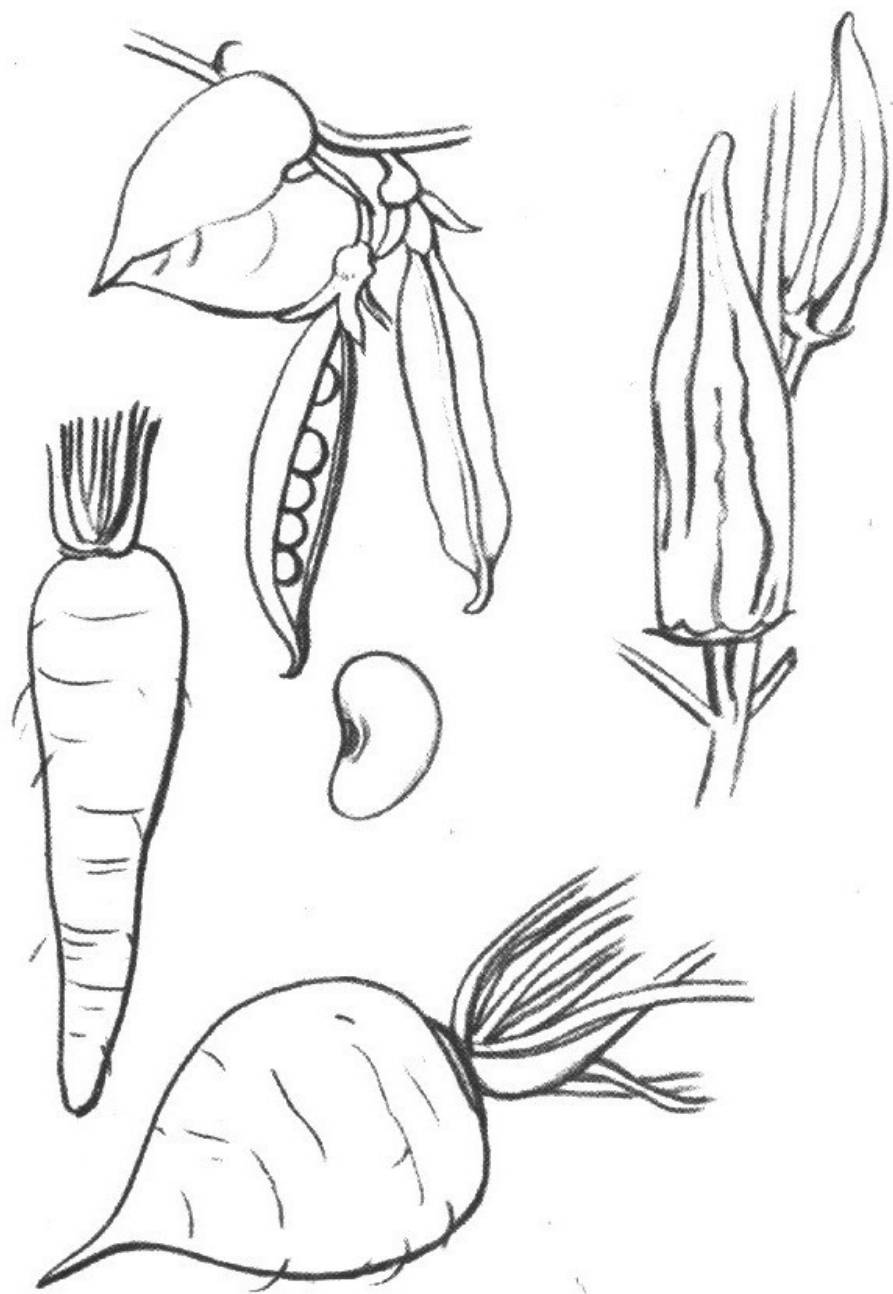

CAPÍTULO V
*
PAISAGEM E MARINHA

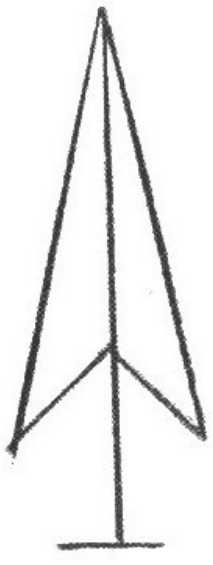

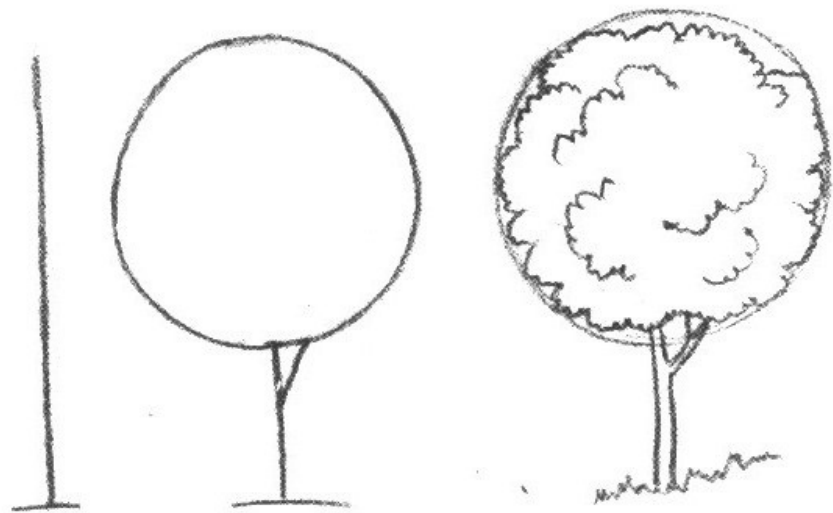
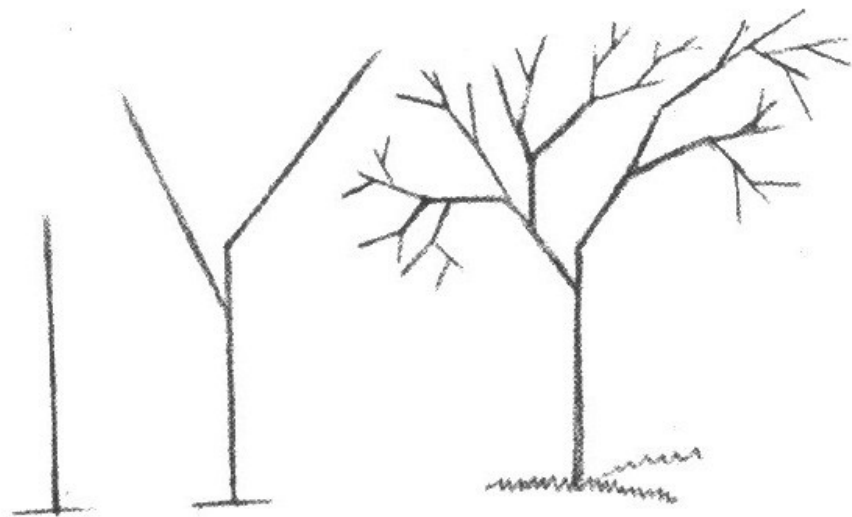
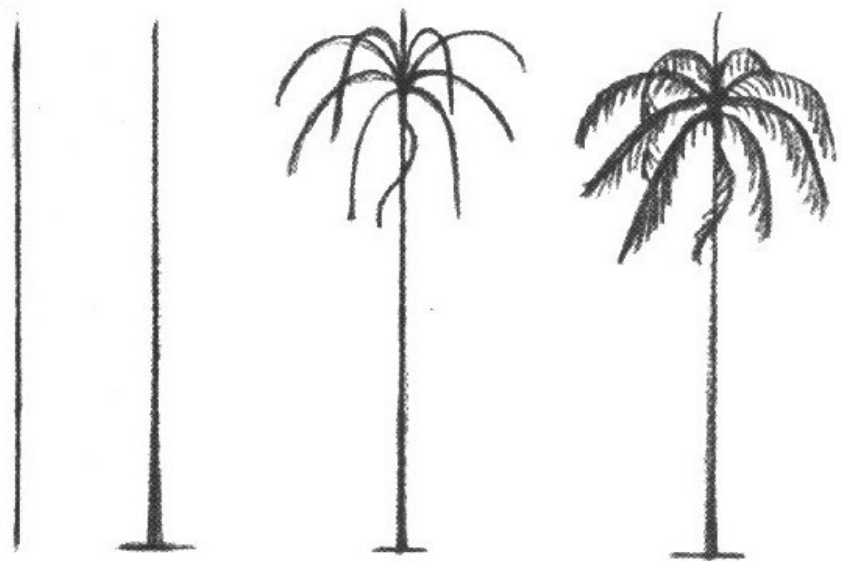

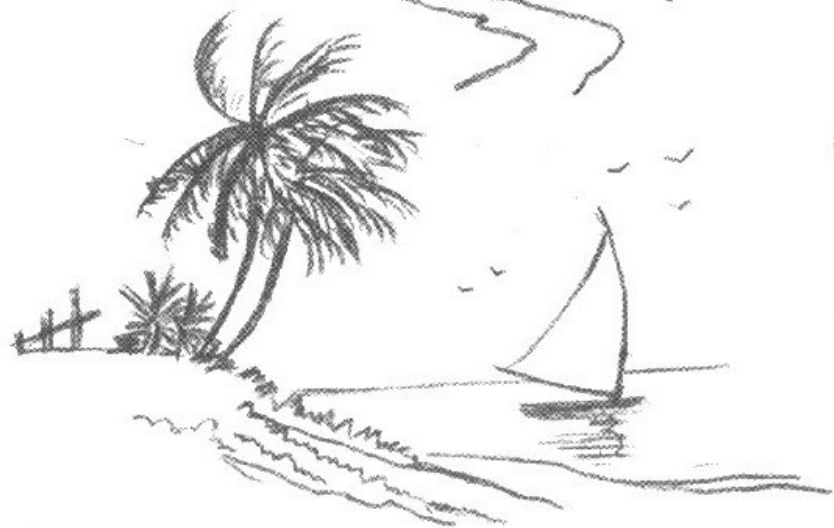
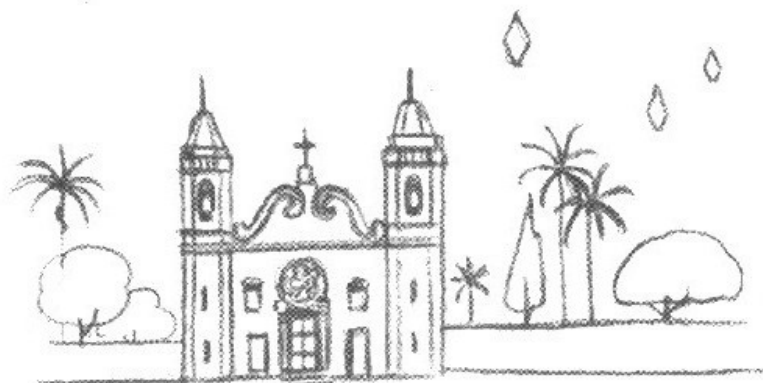
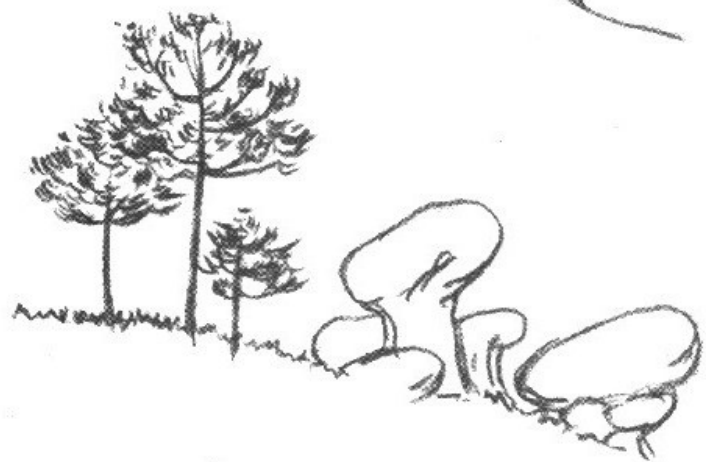
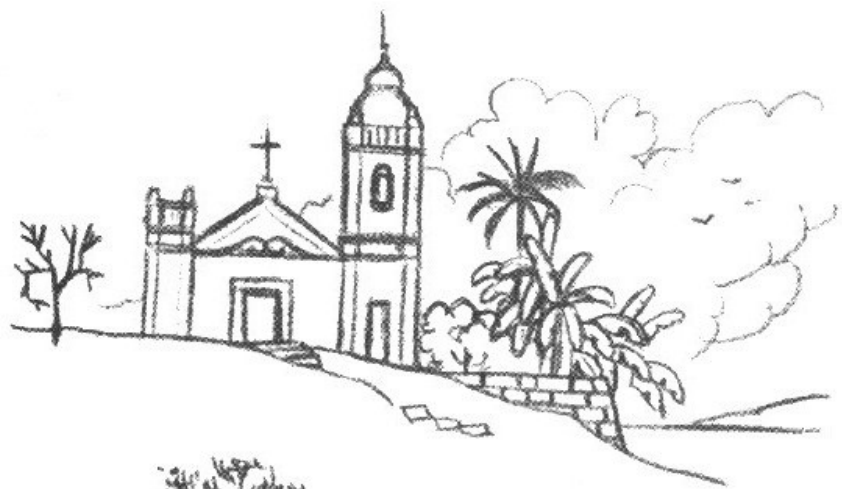

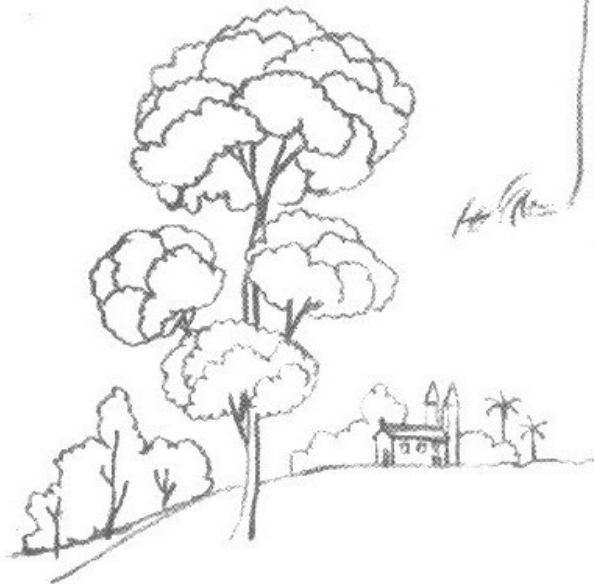
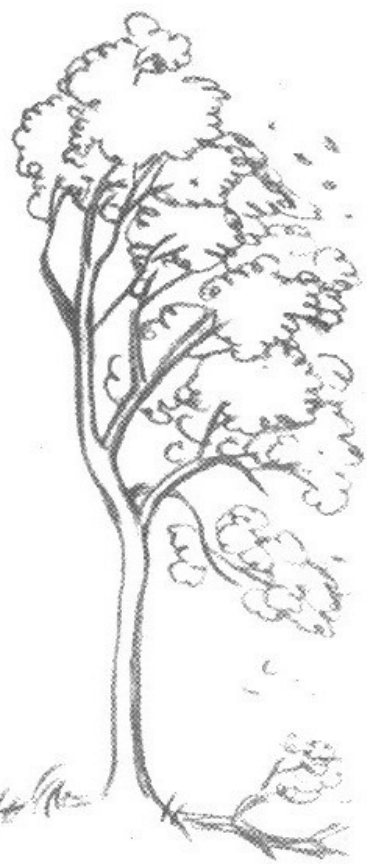
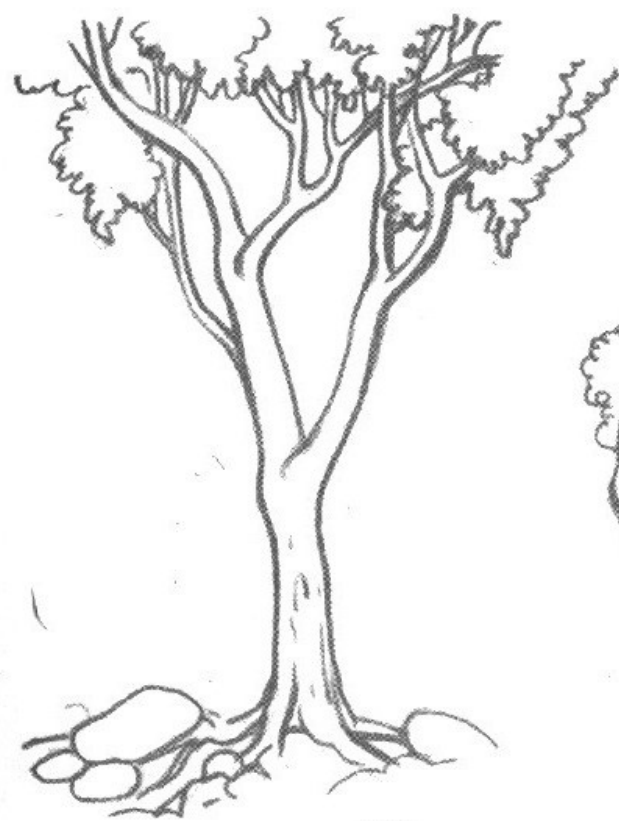

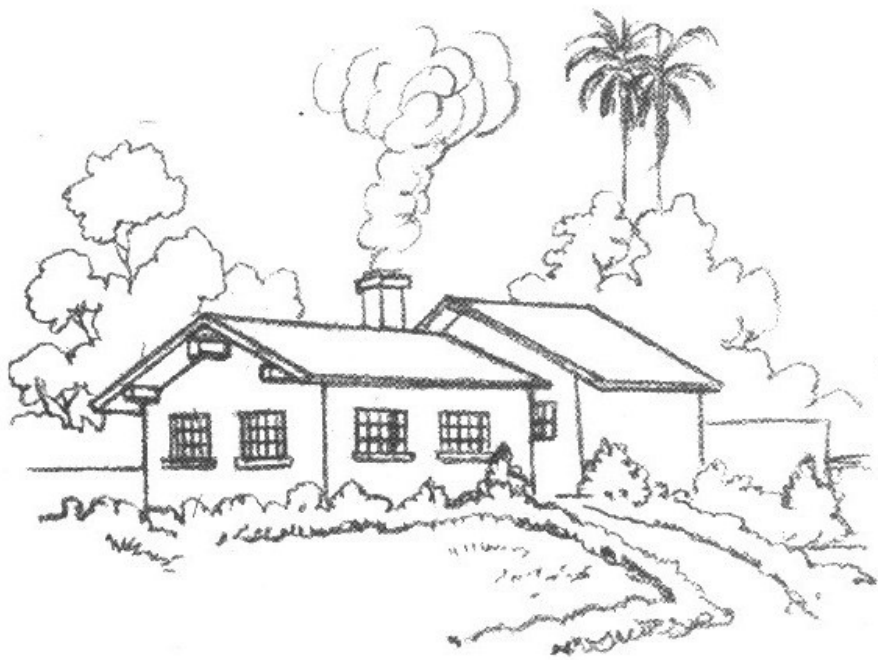
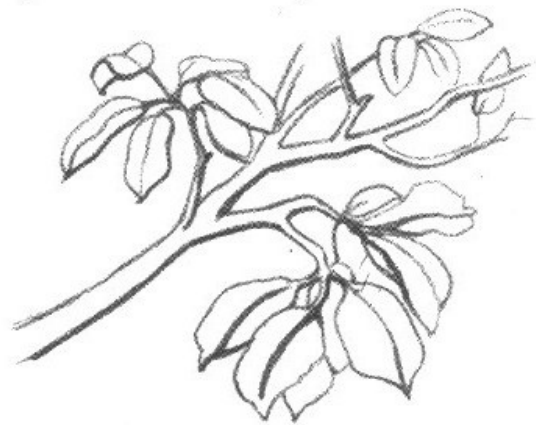

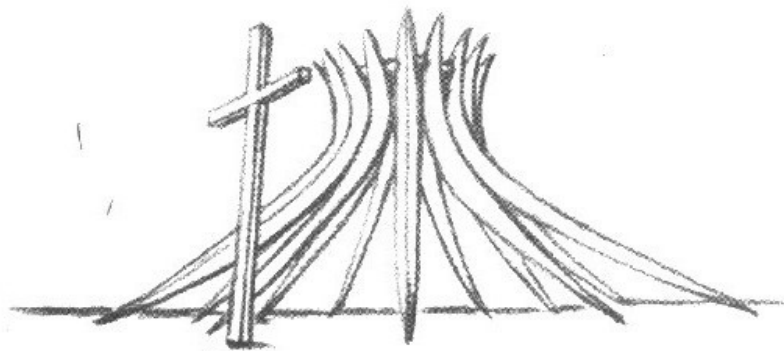

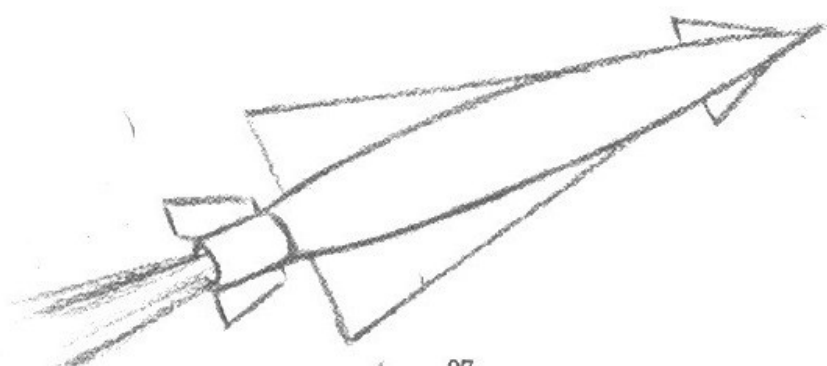
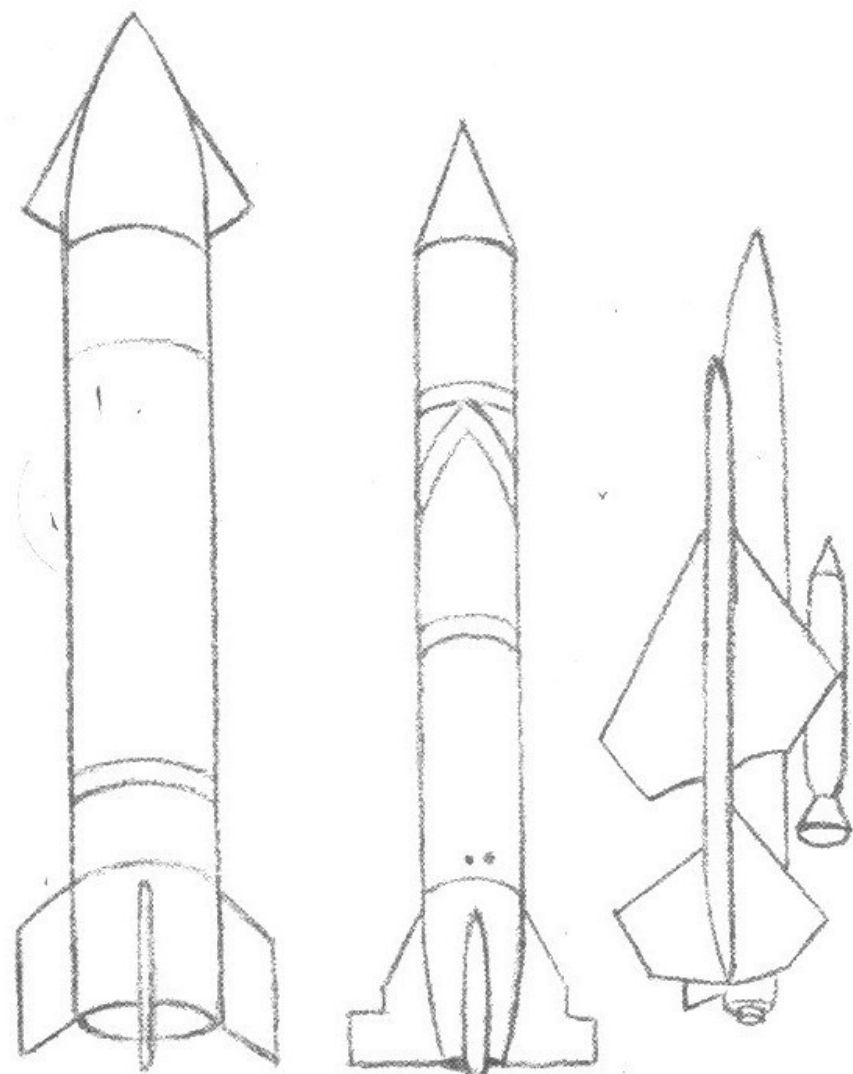
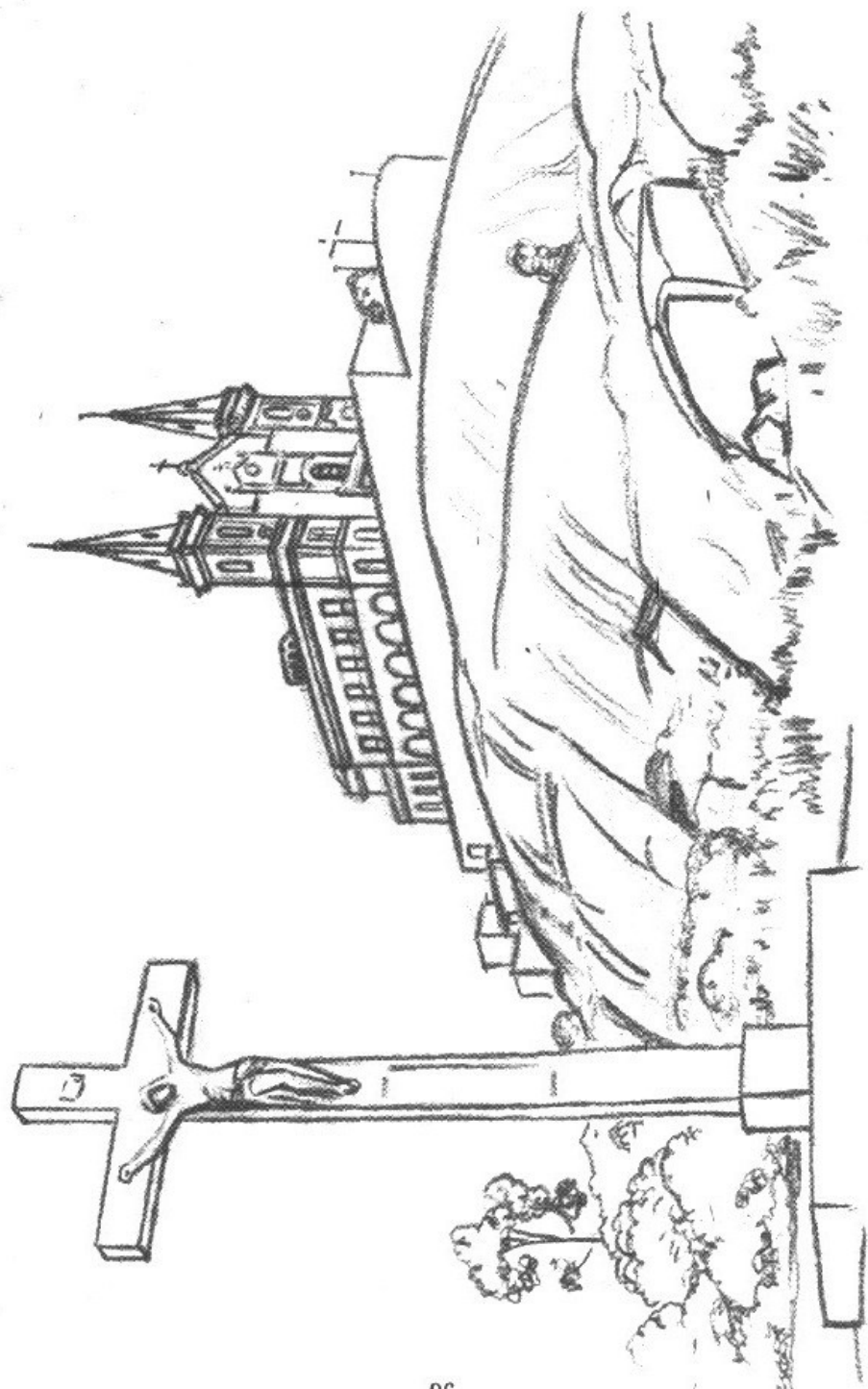

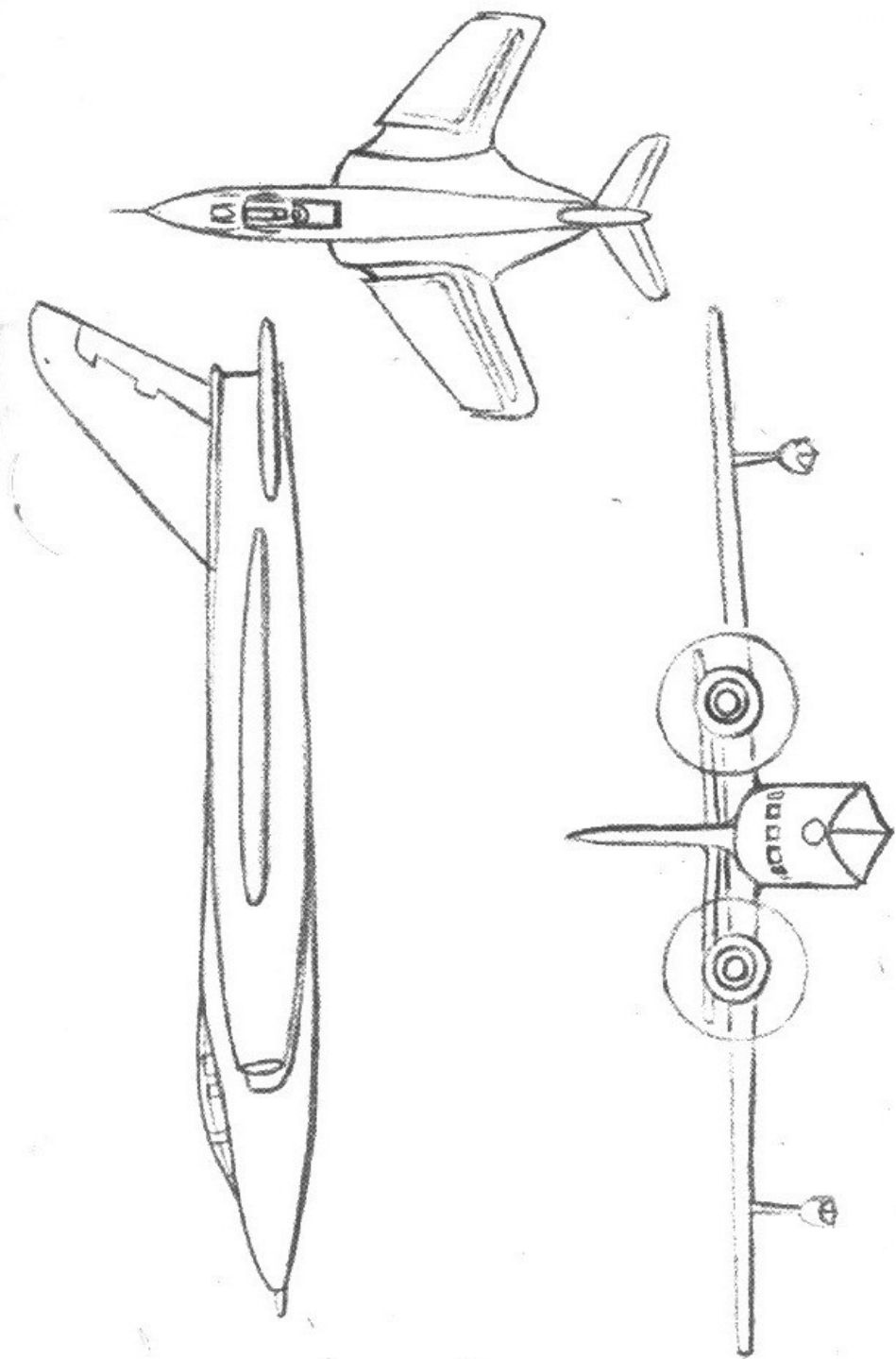
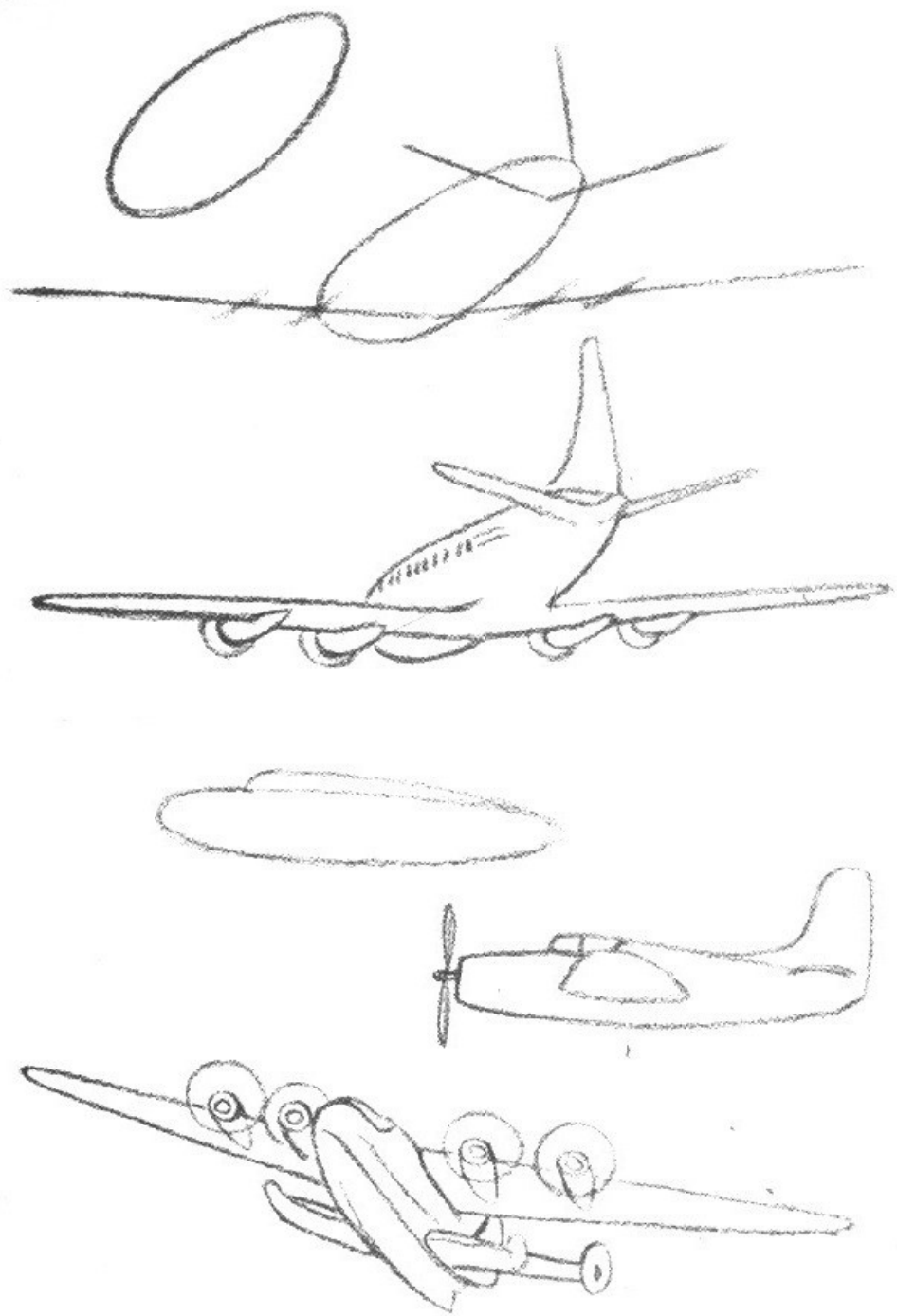

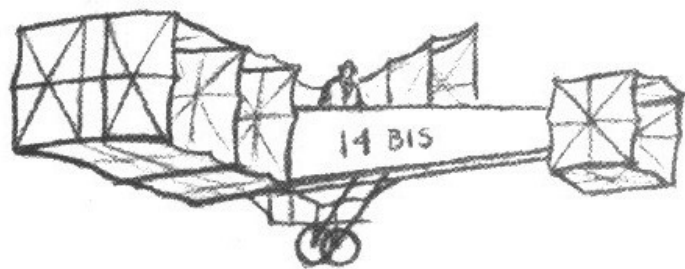
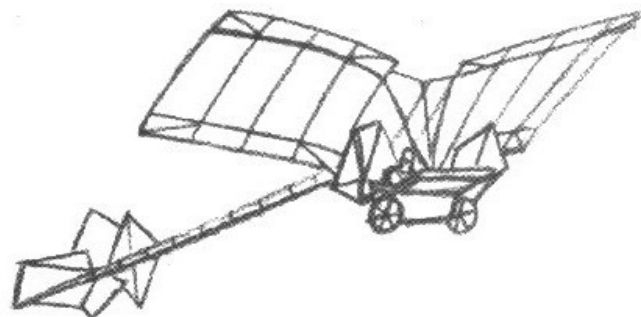
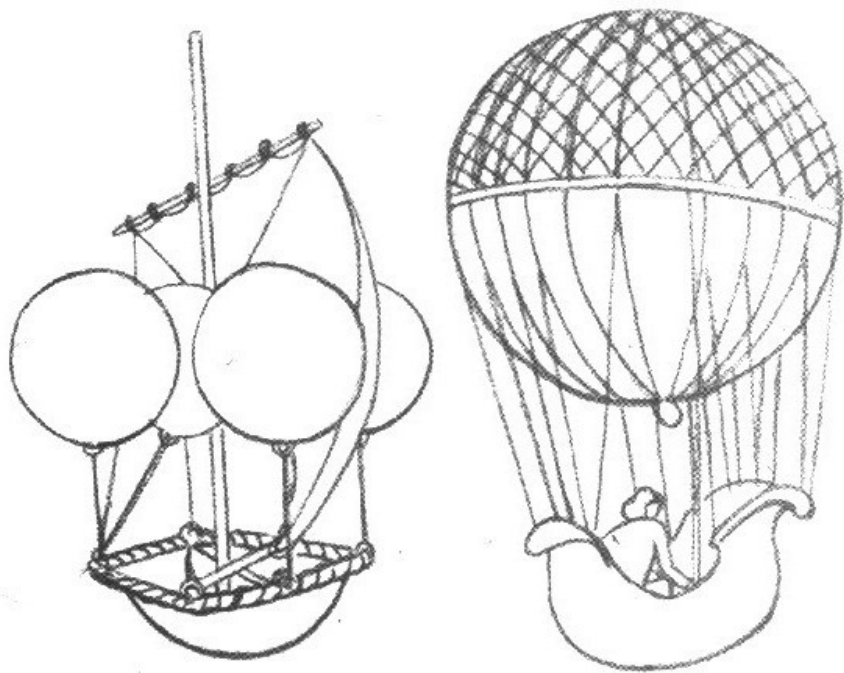
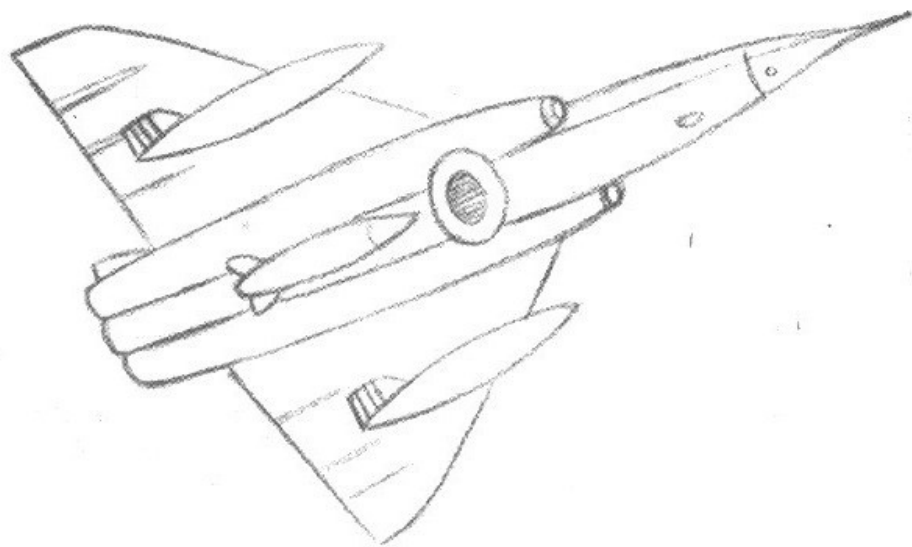
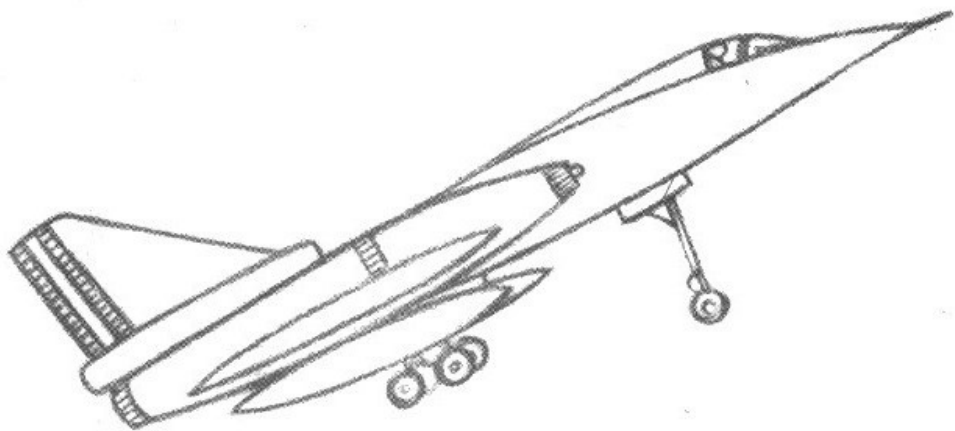
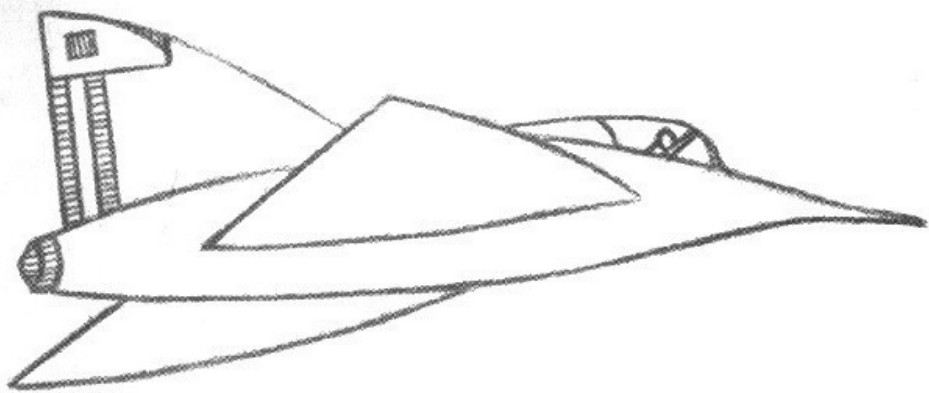

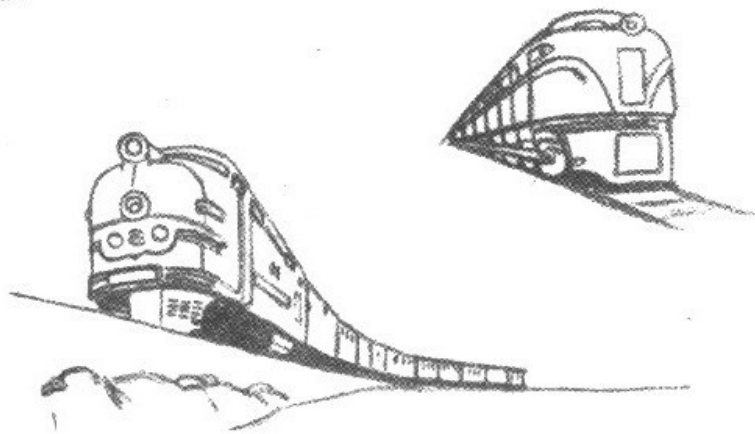
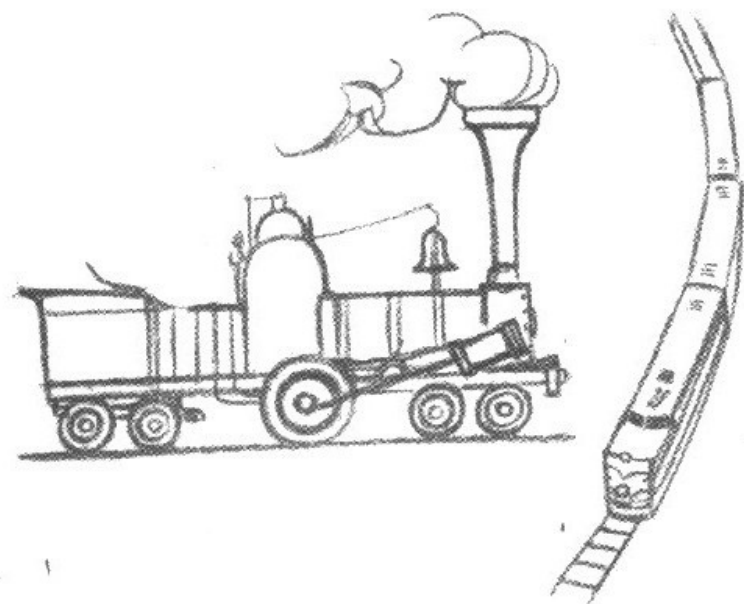
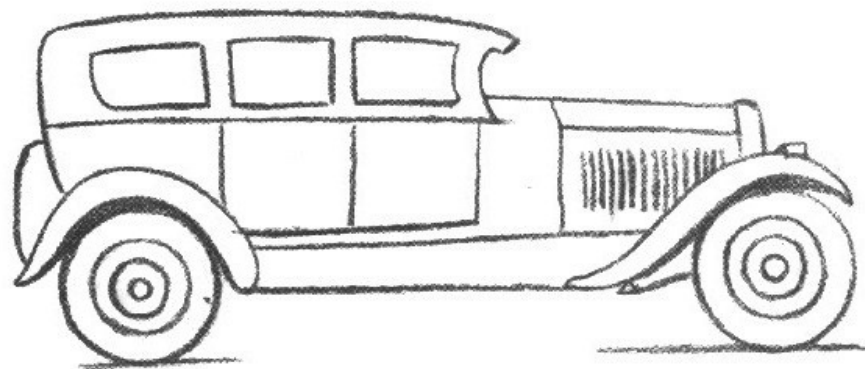
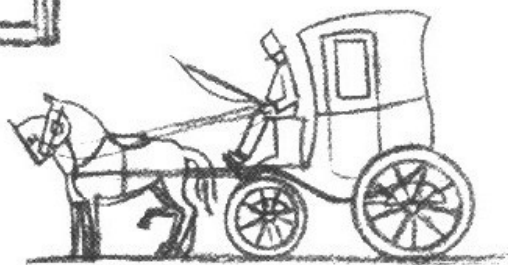
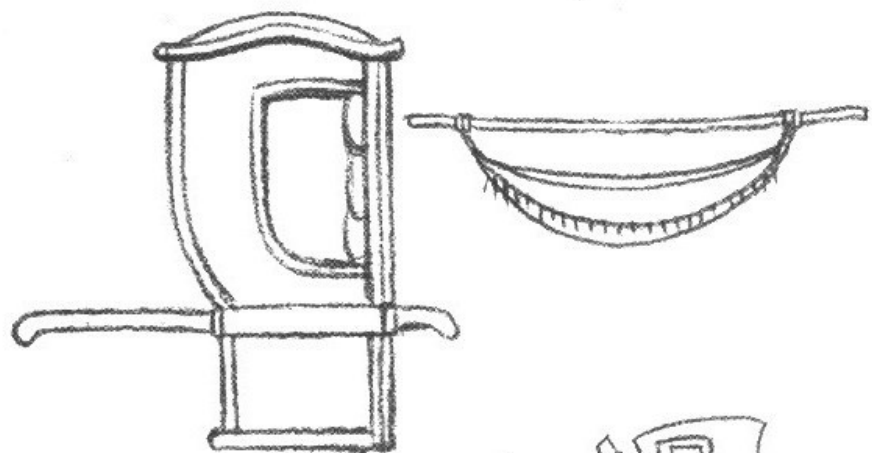

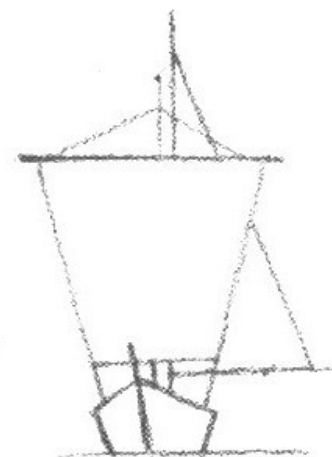
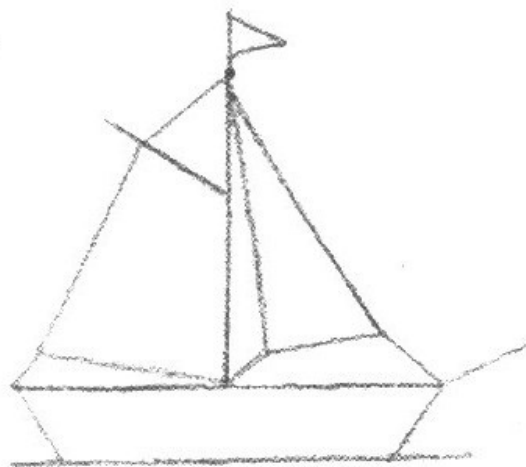
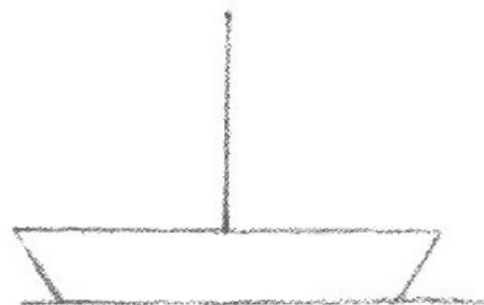
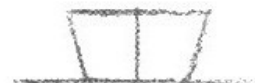
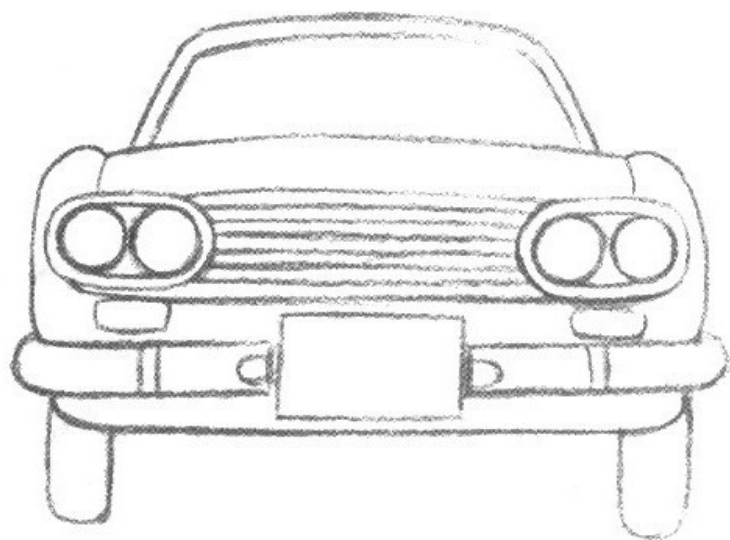
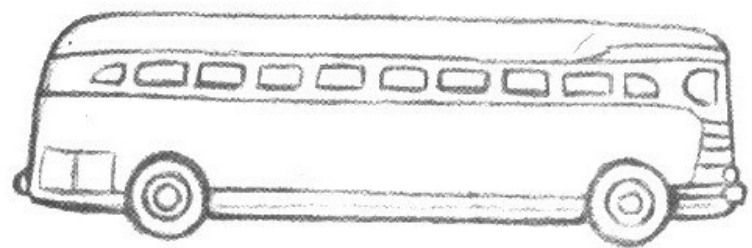
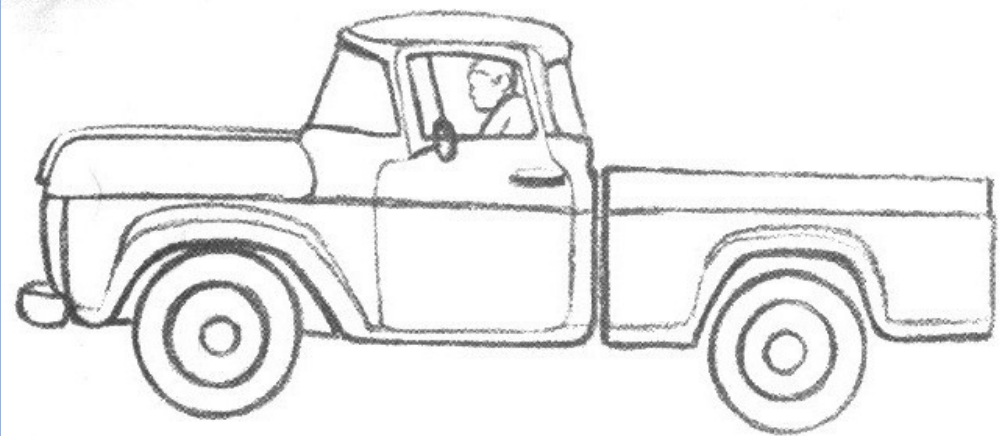

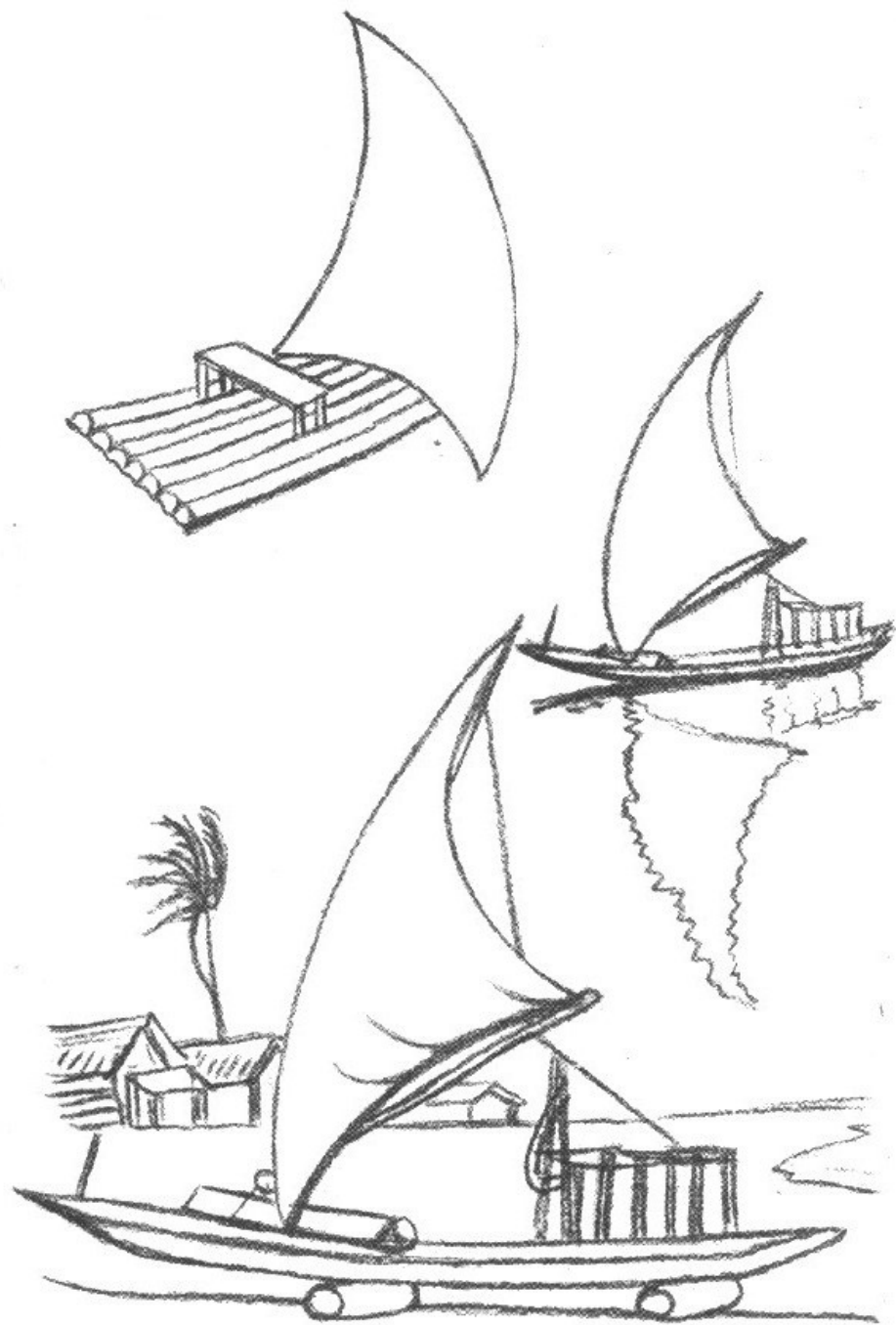
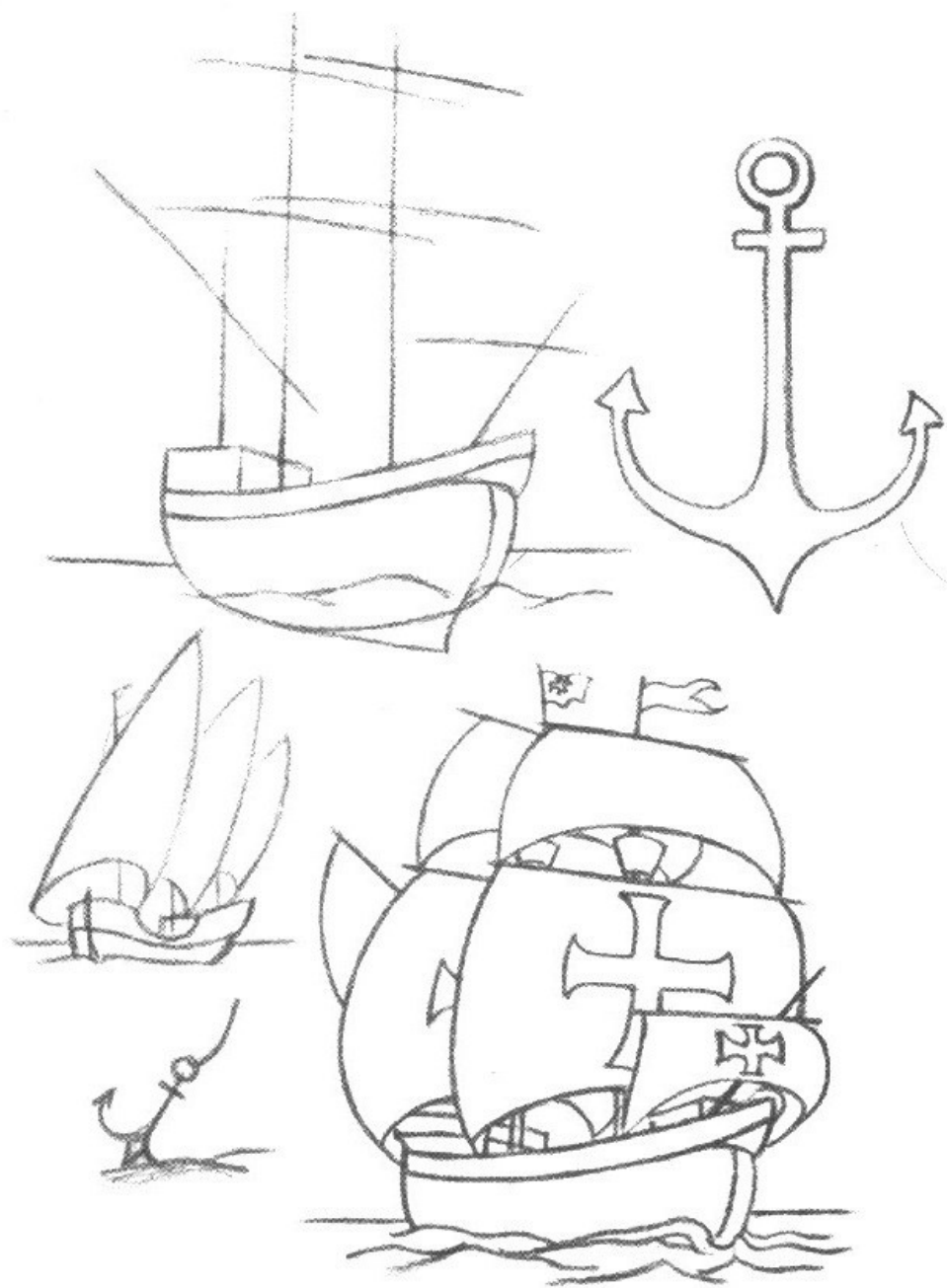

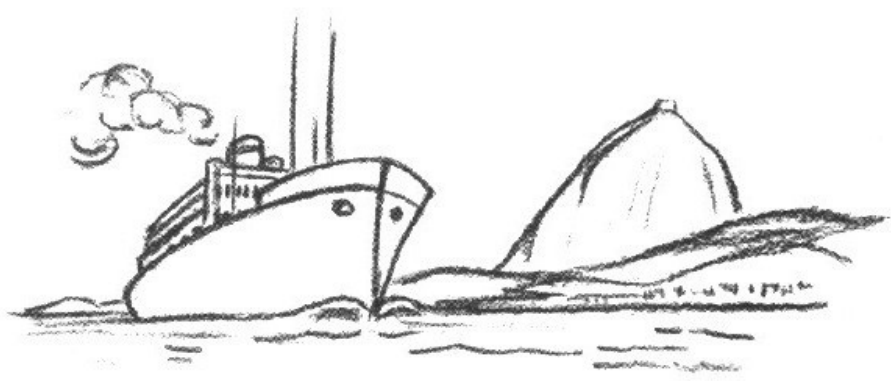
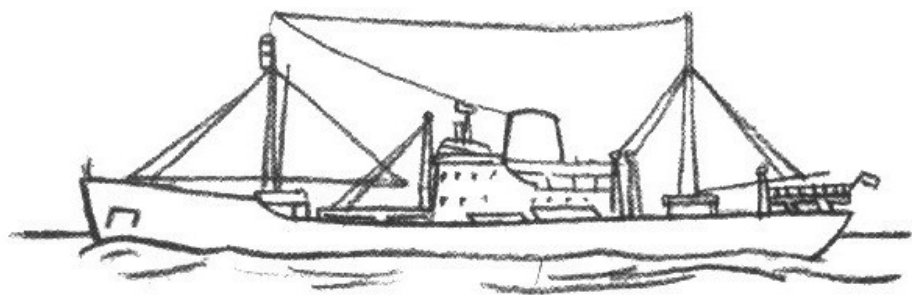
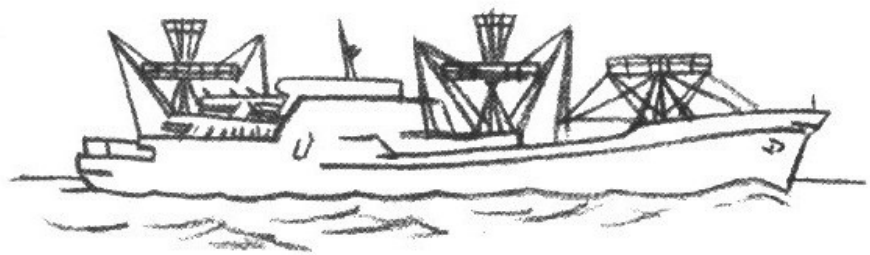

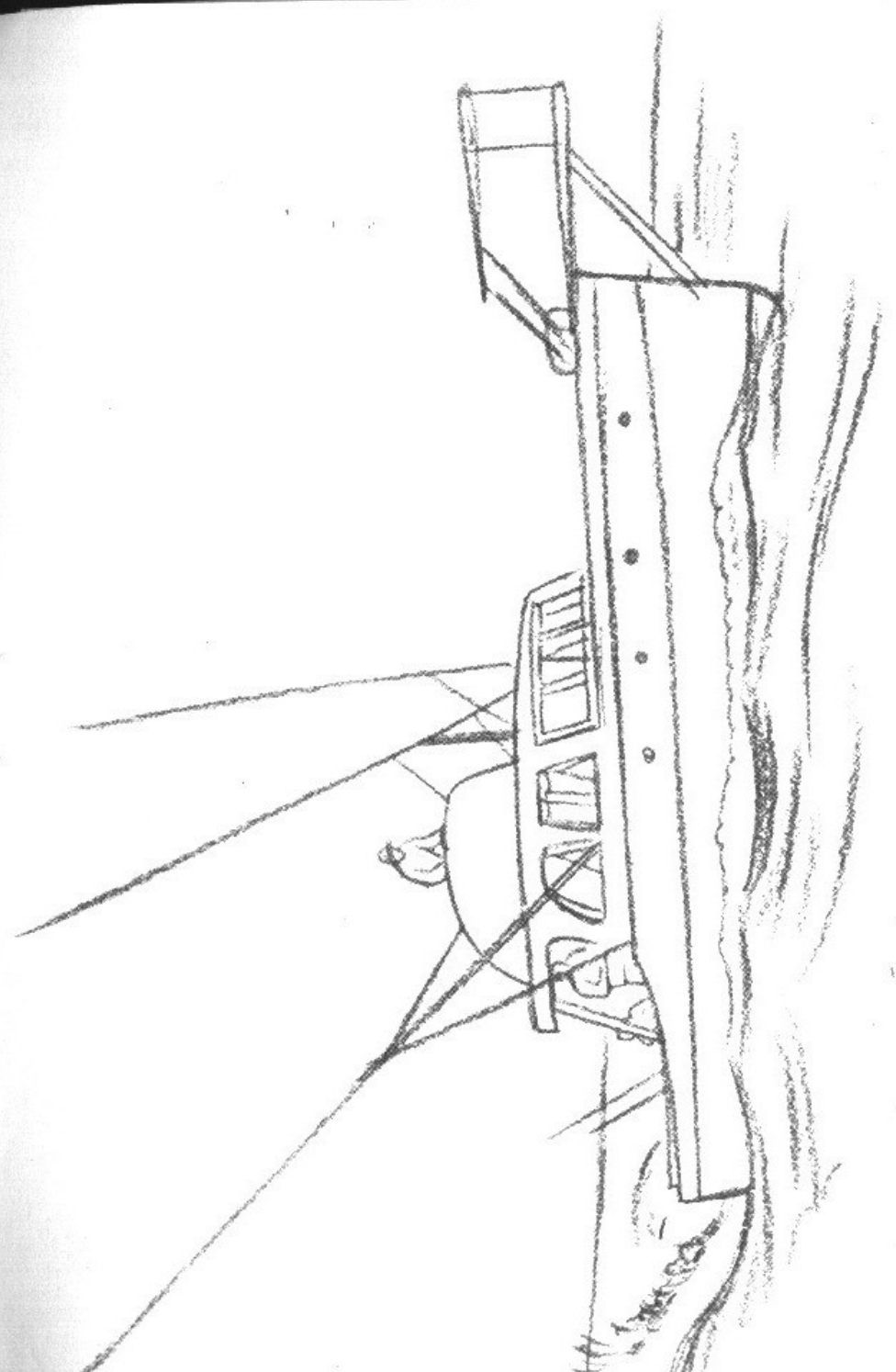
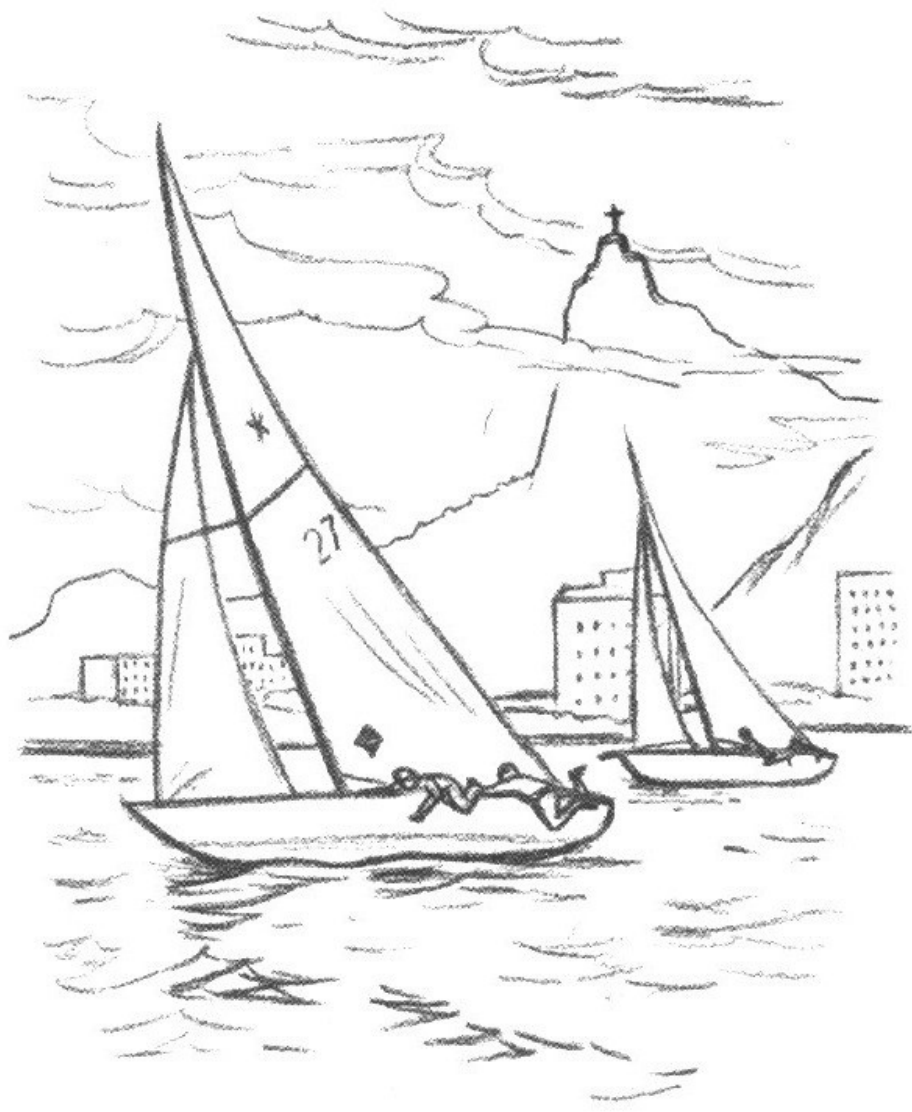

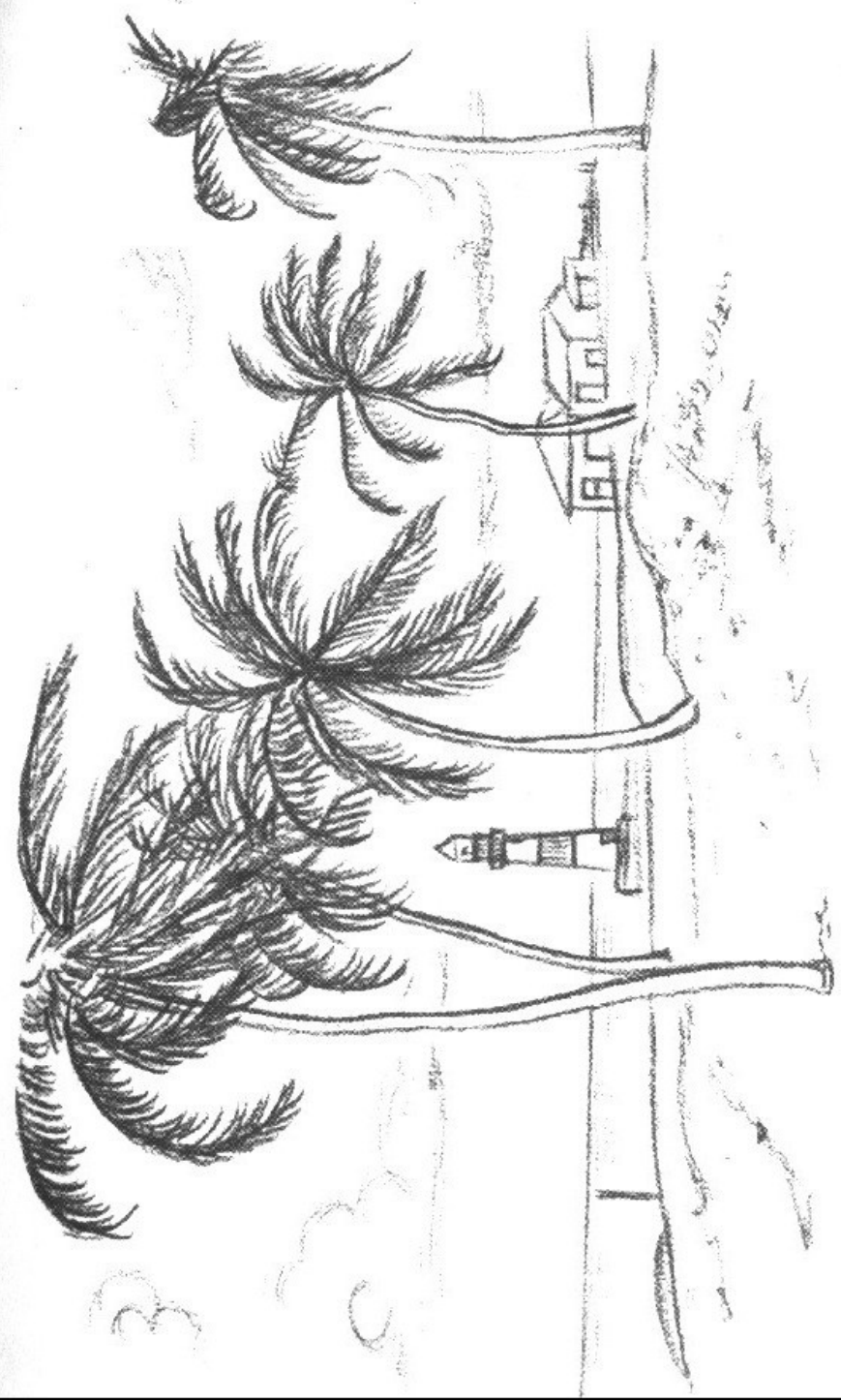
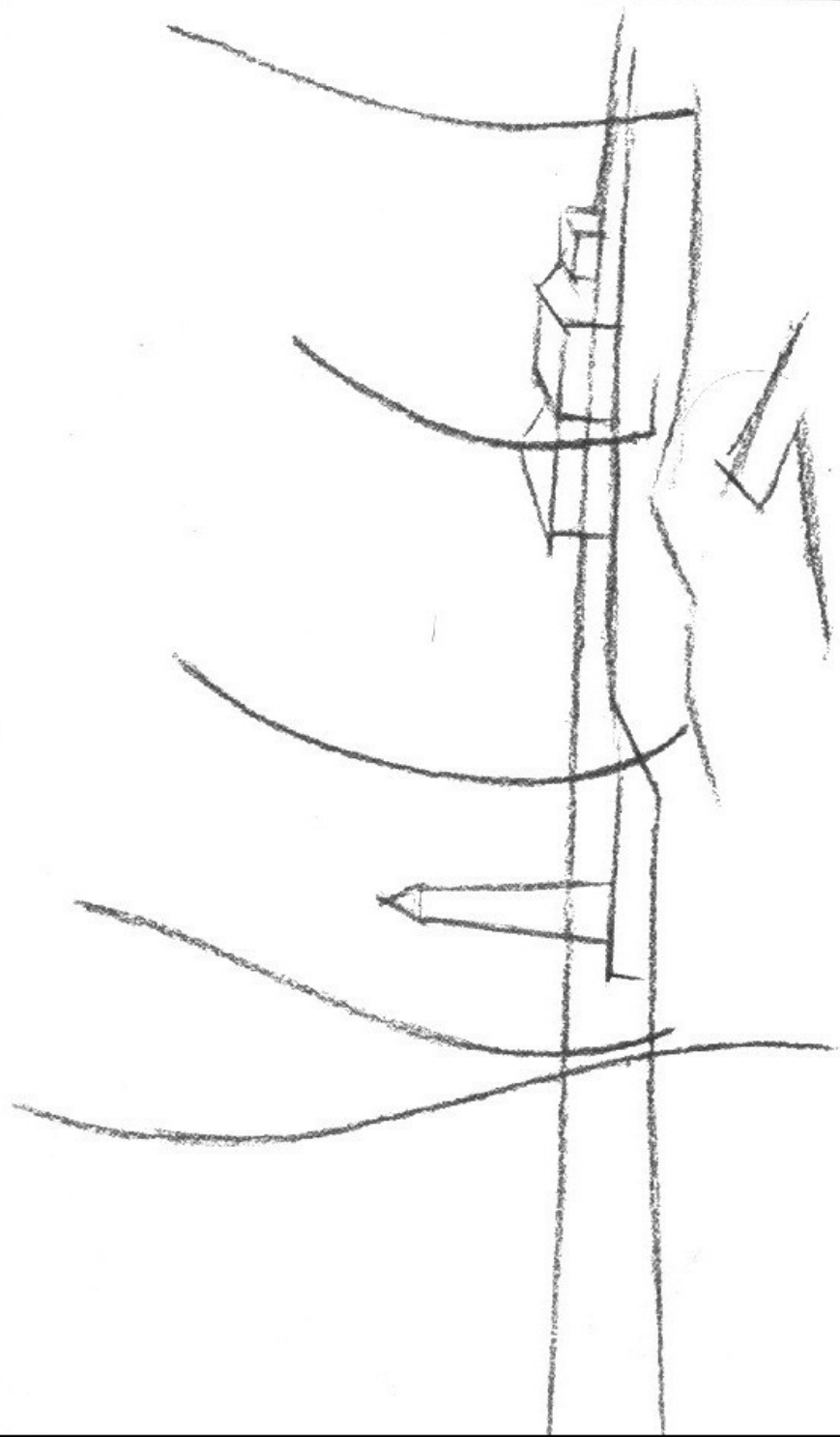

CAPÍTULO VI
*
ANIMAIS

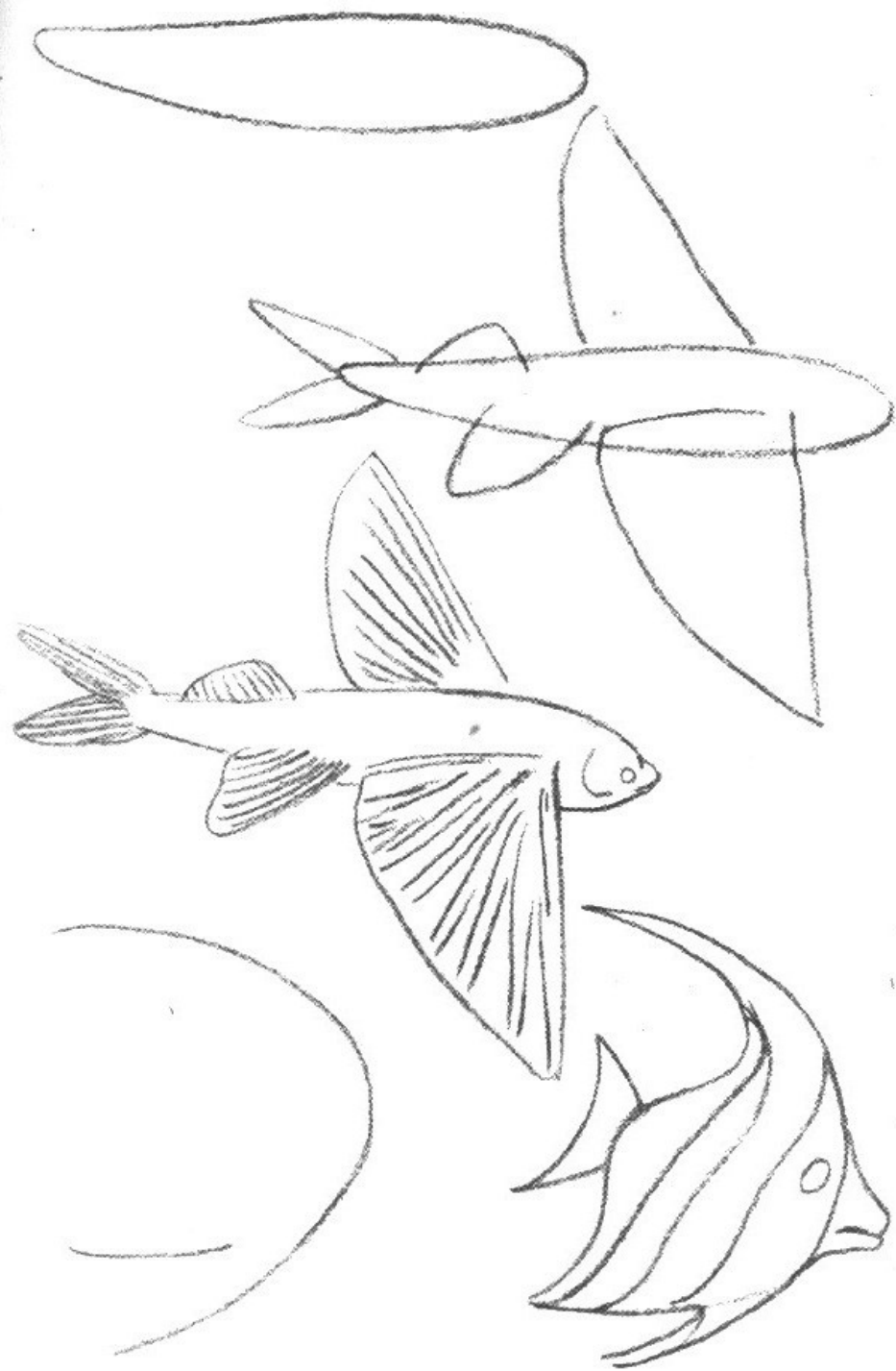

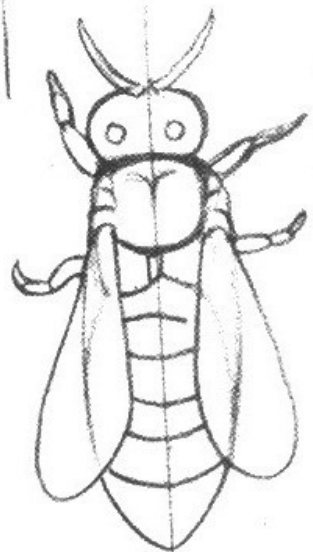
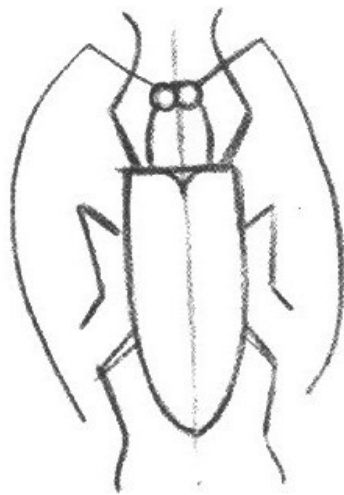
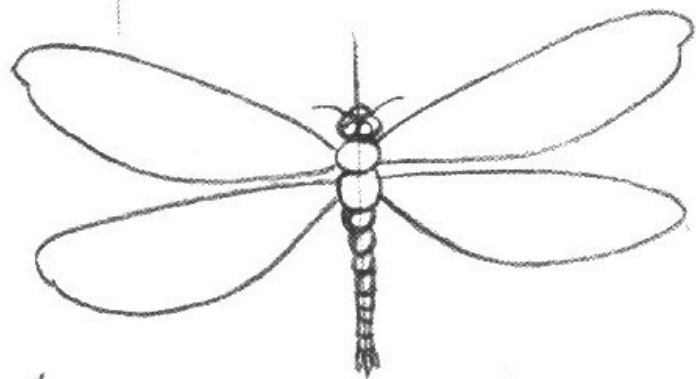
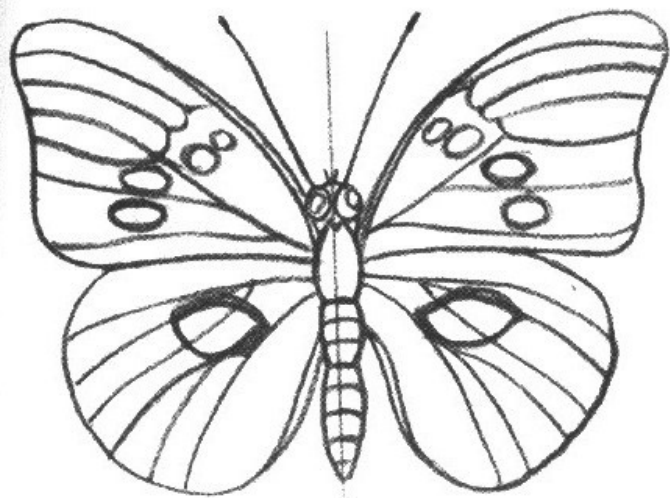
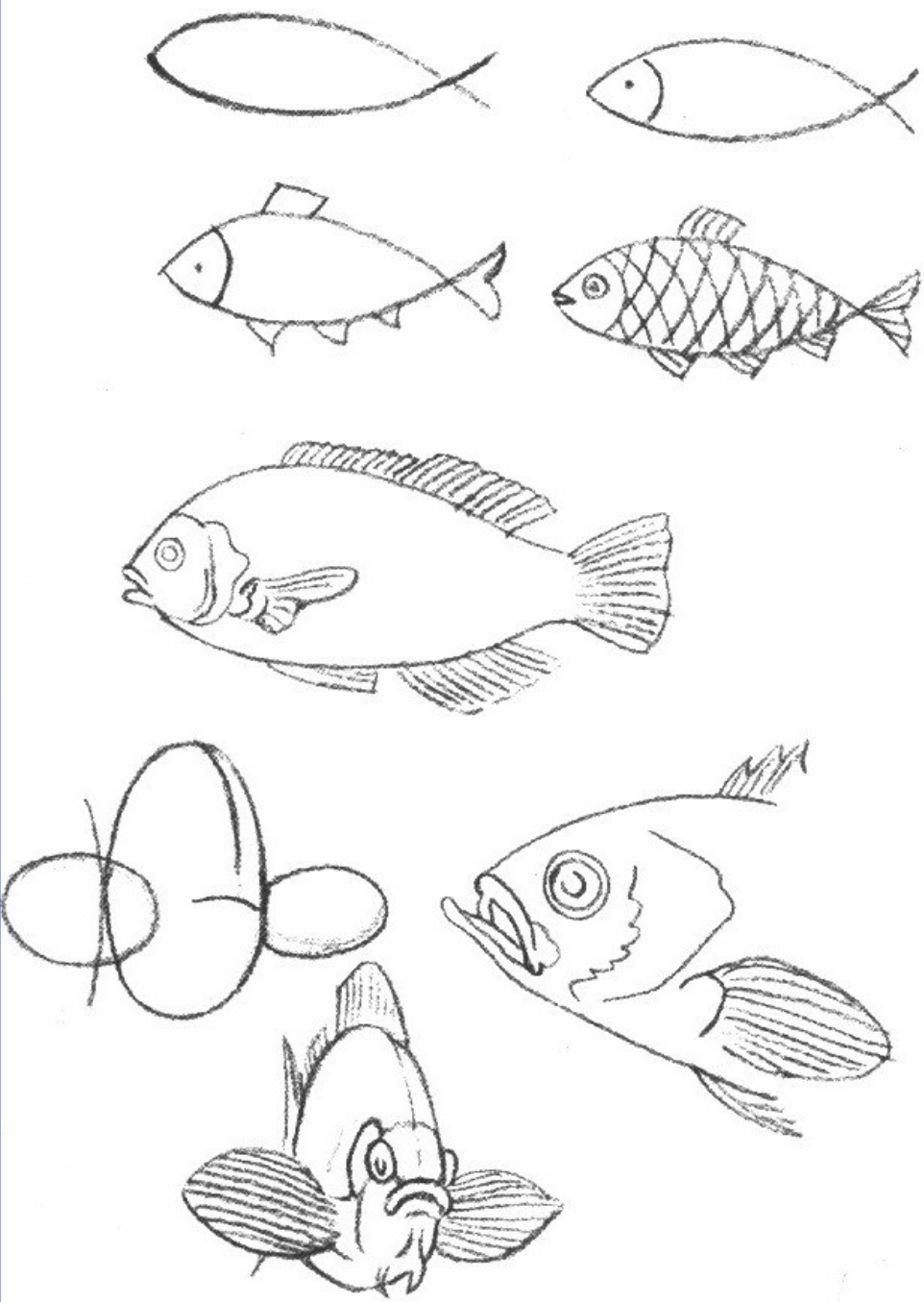

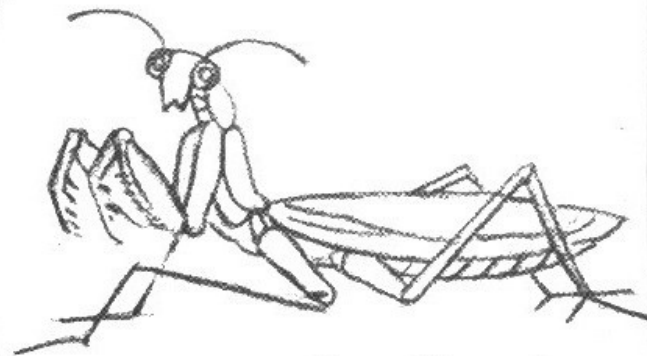
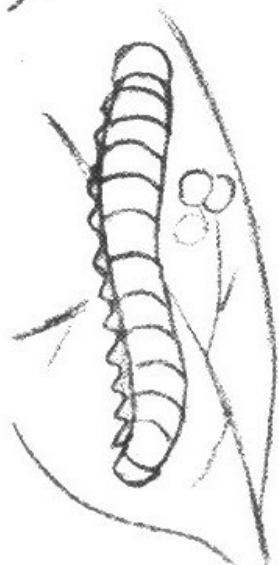
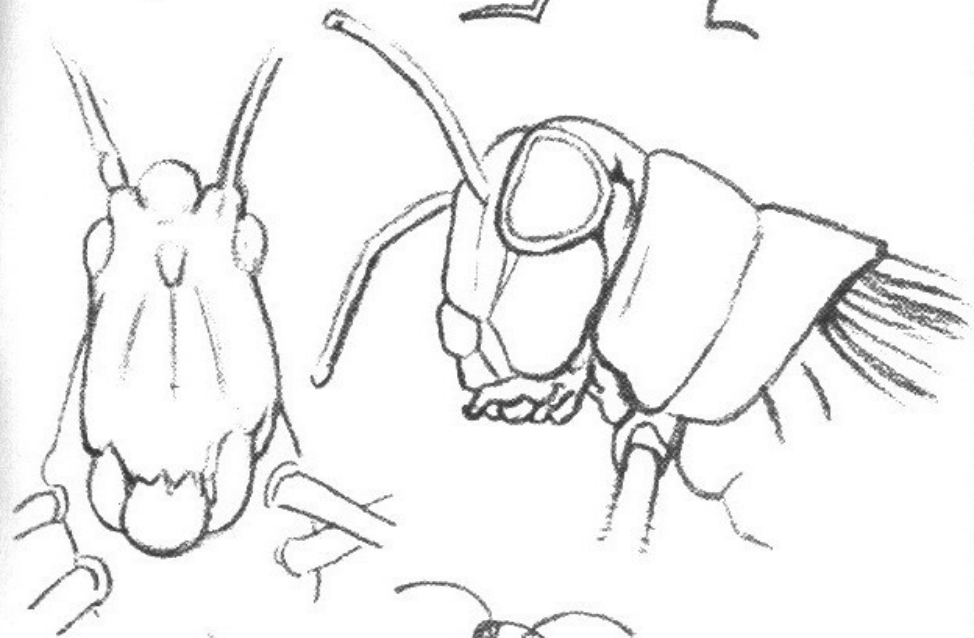
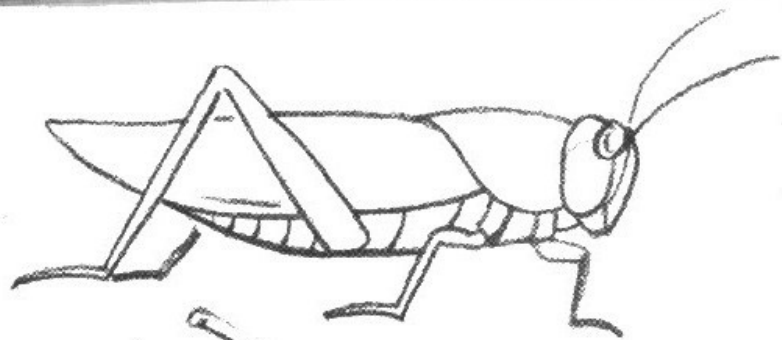
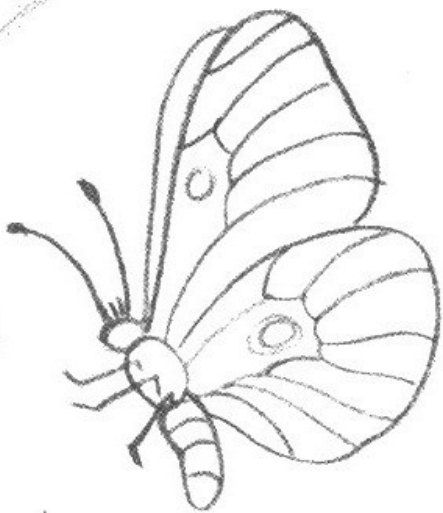
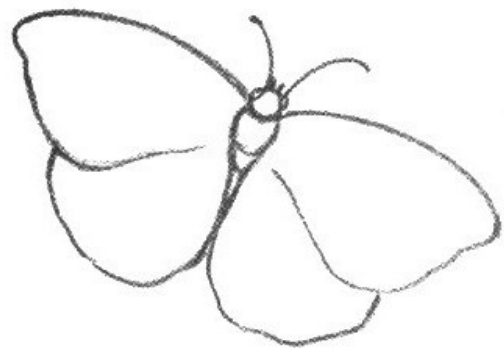
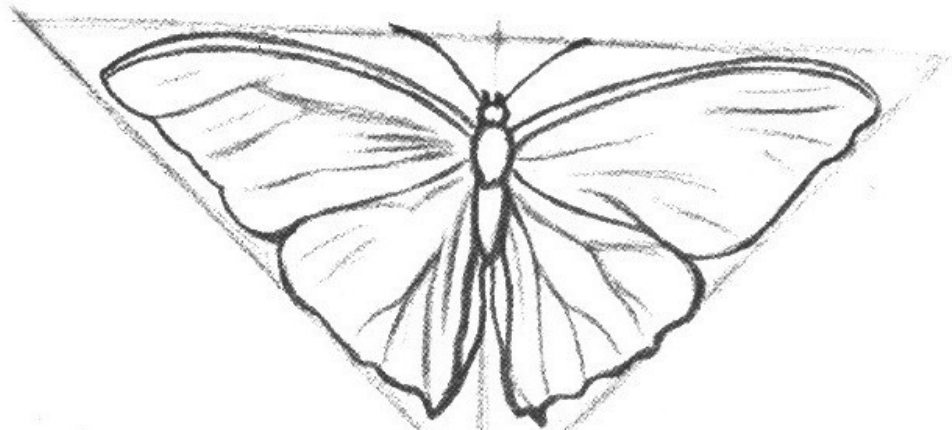

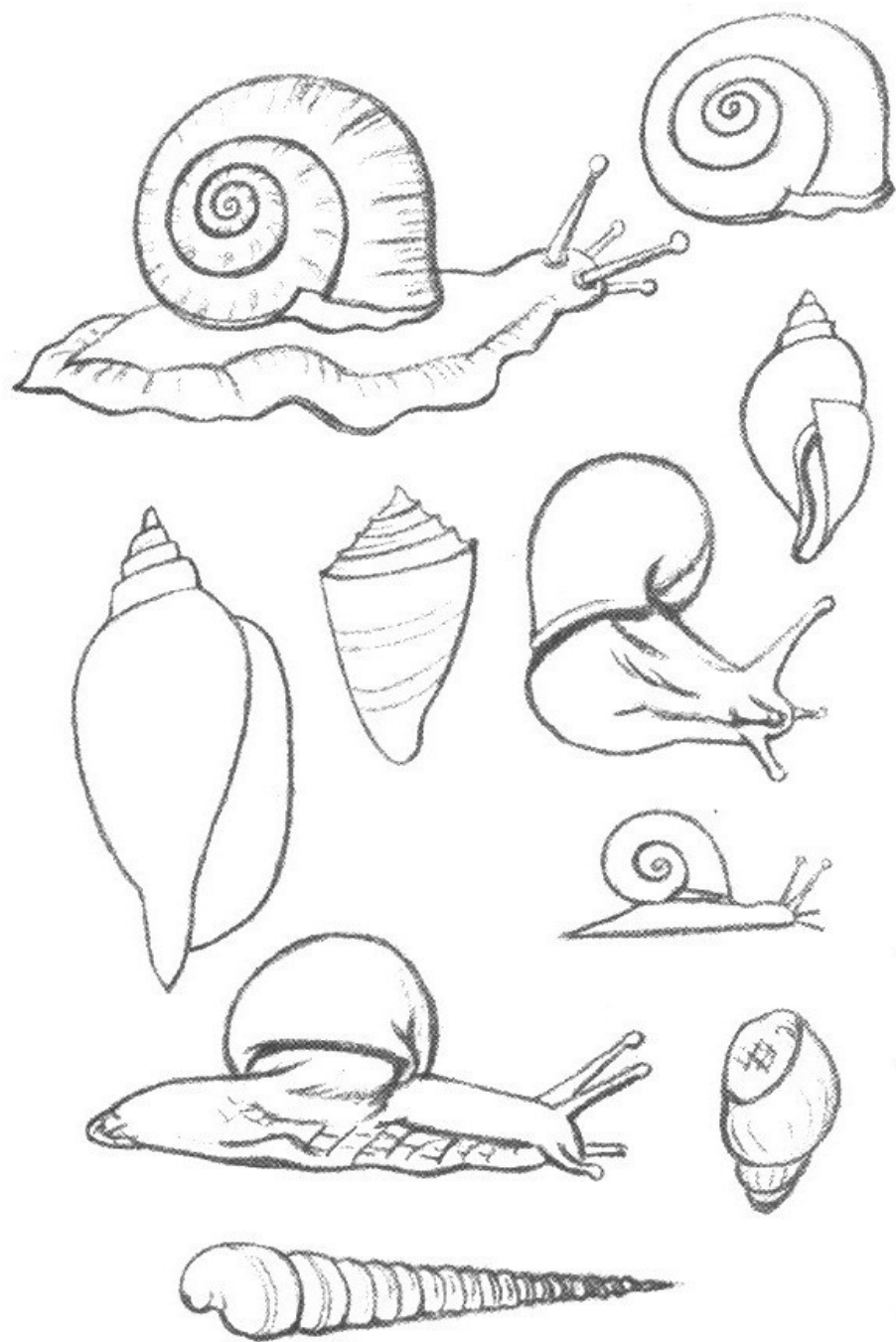
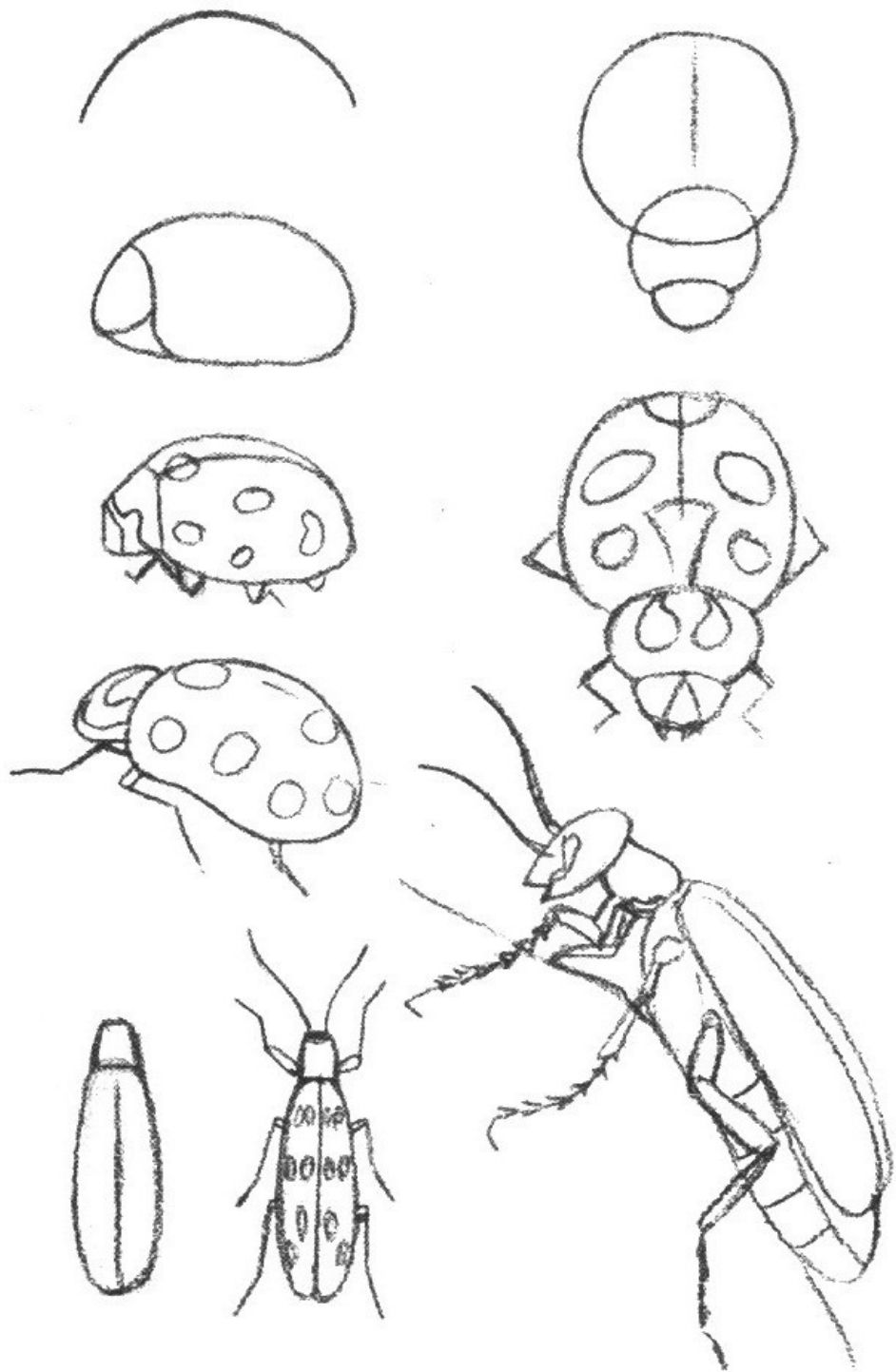

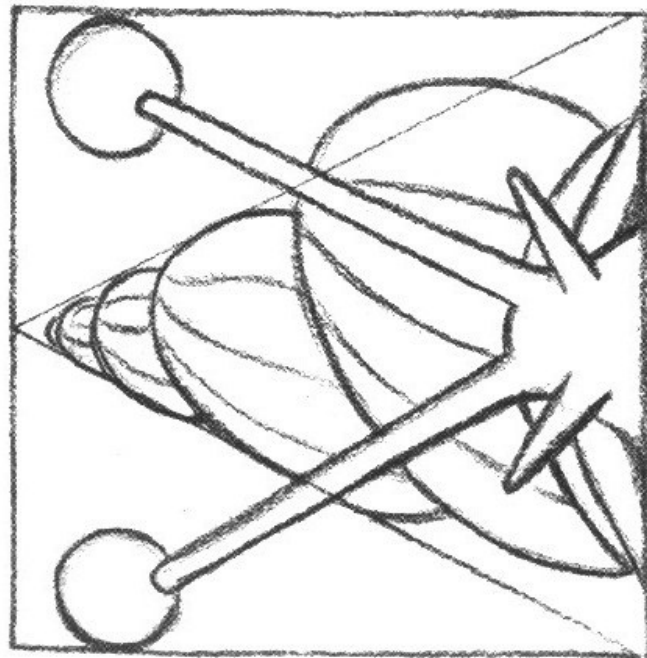
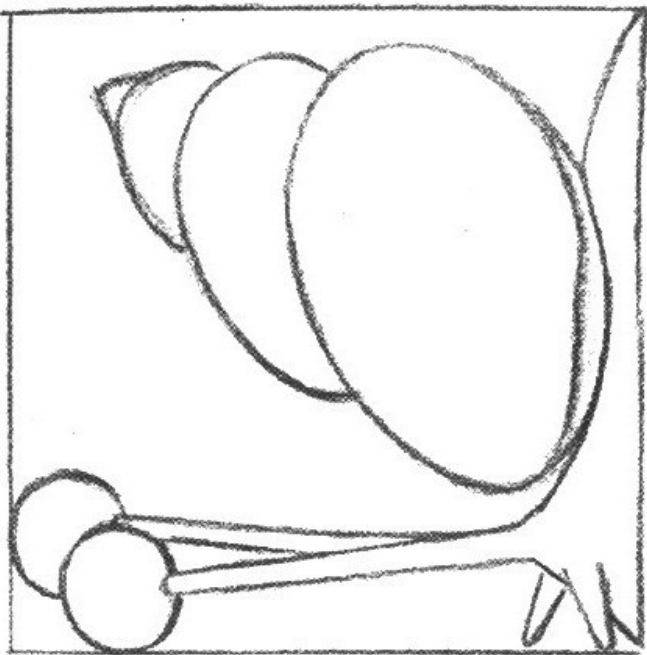

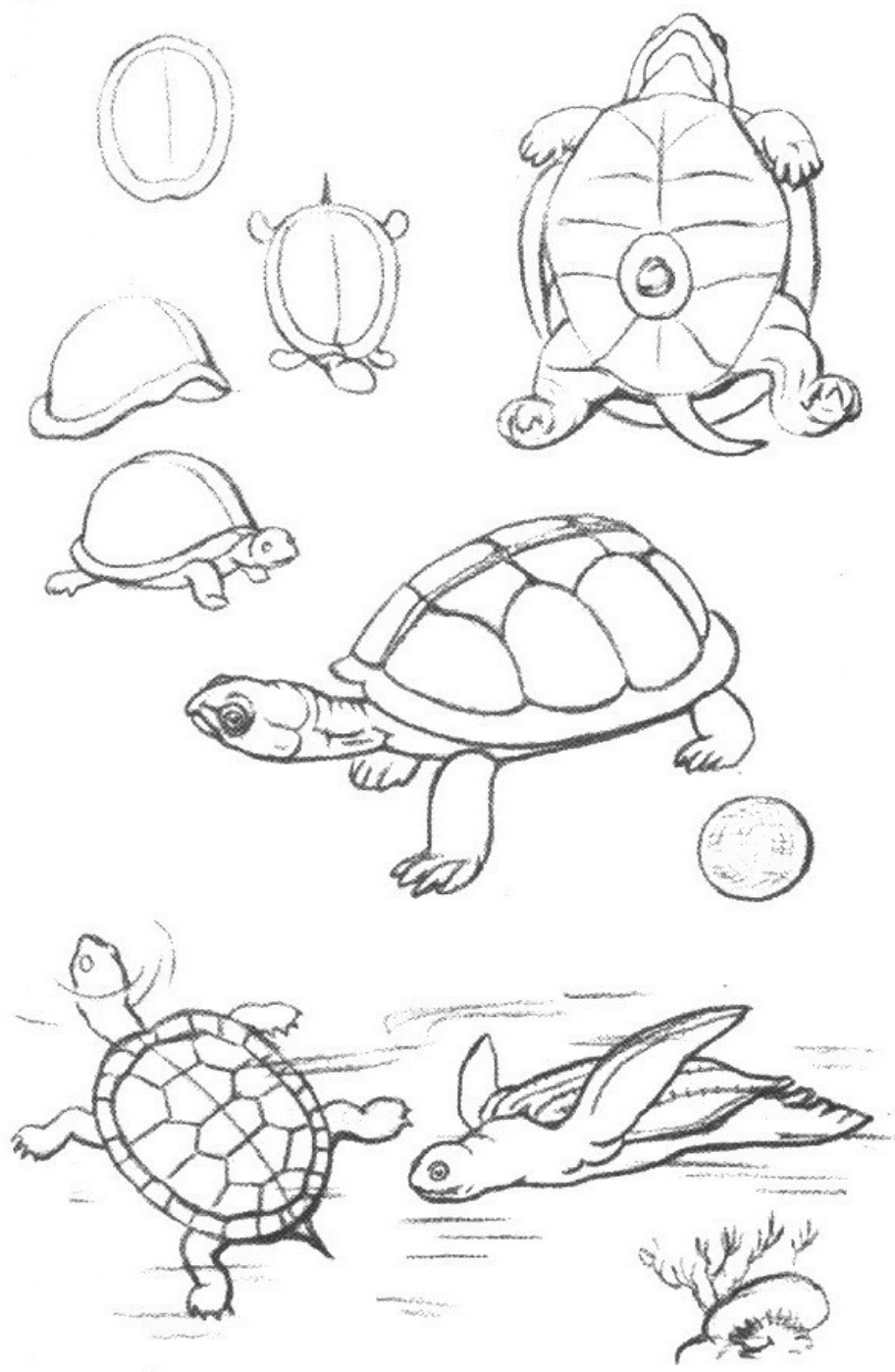

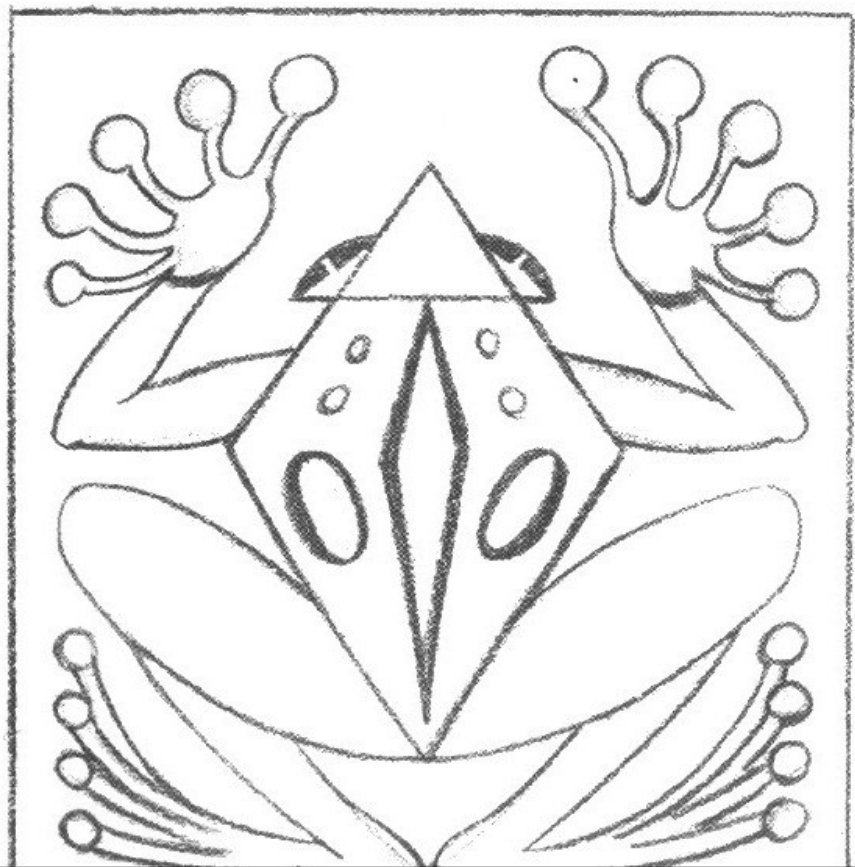
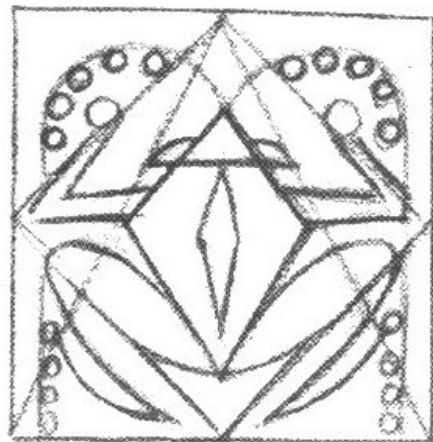
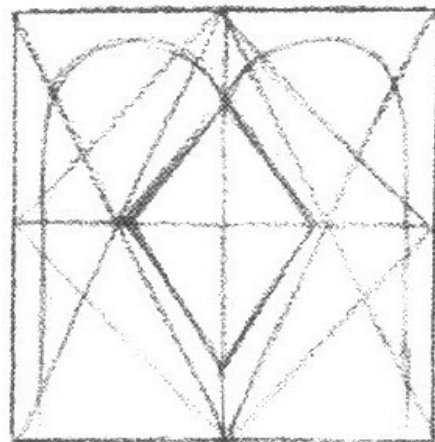
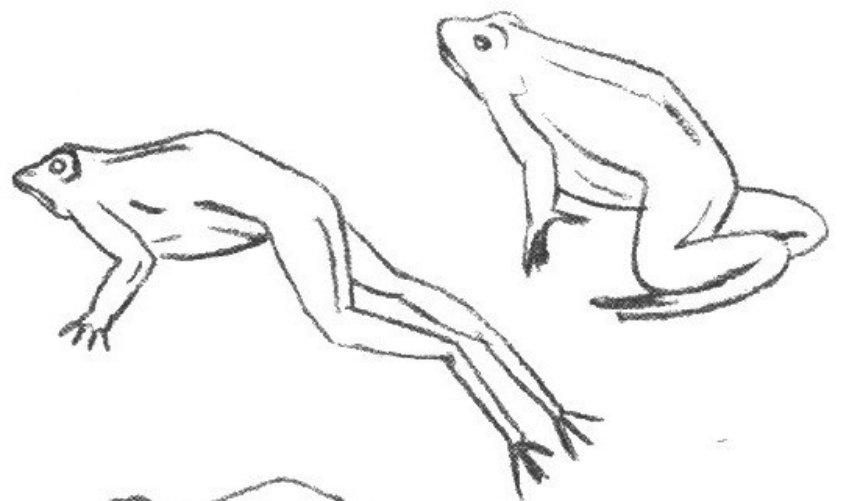
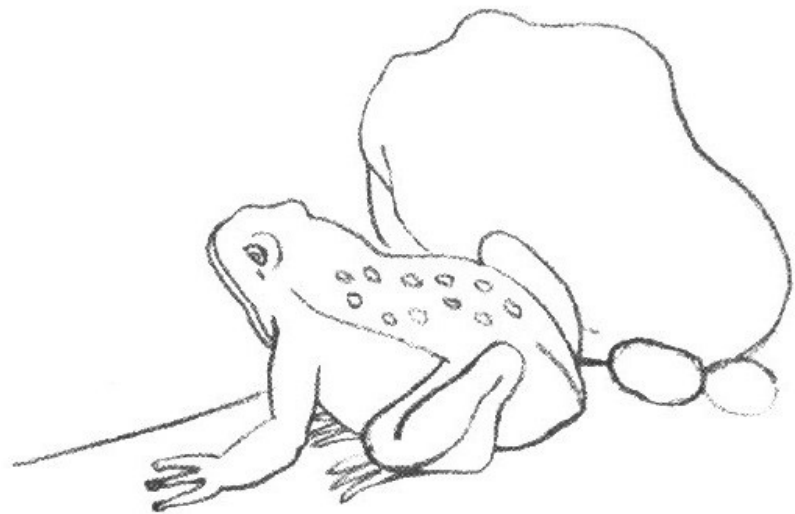

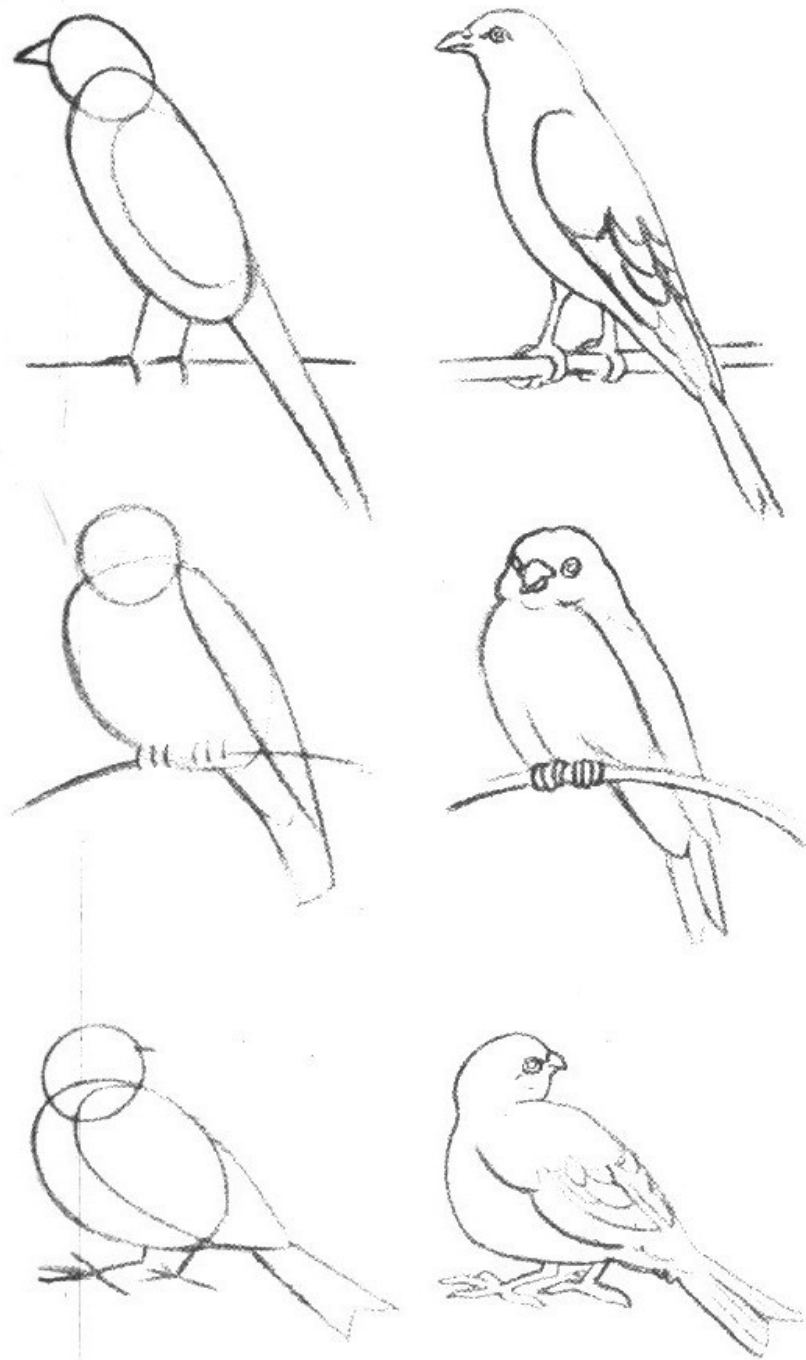
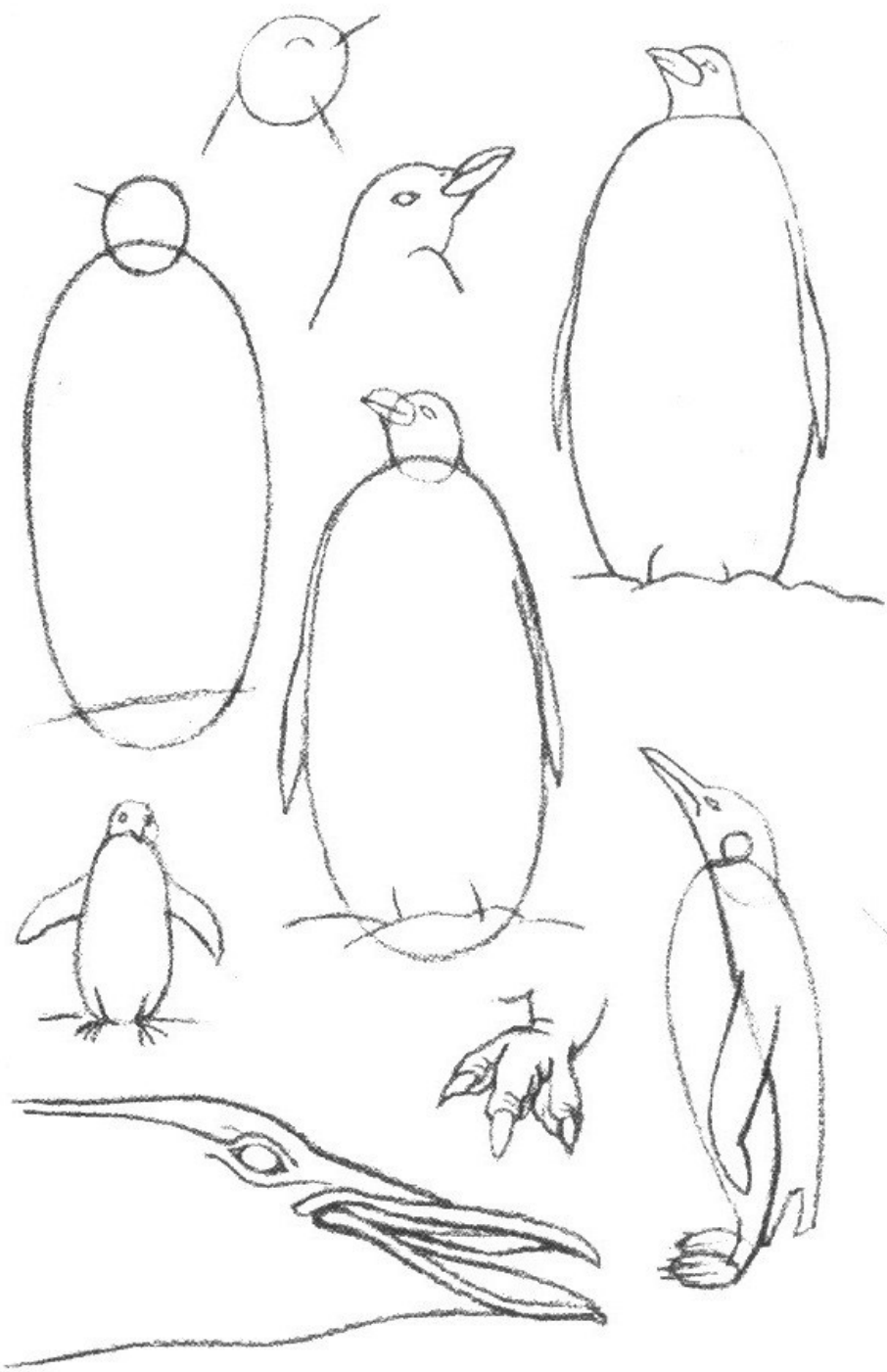

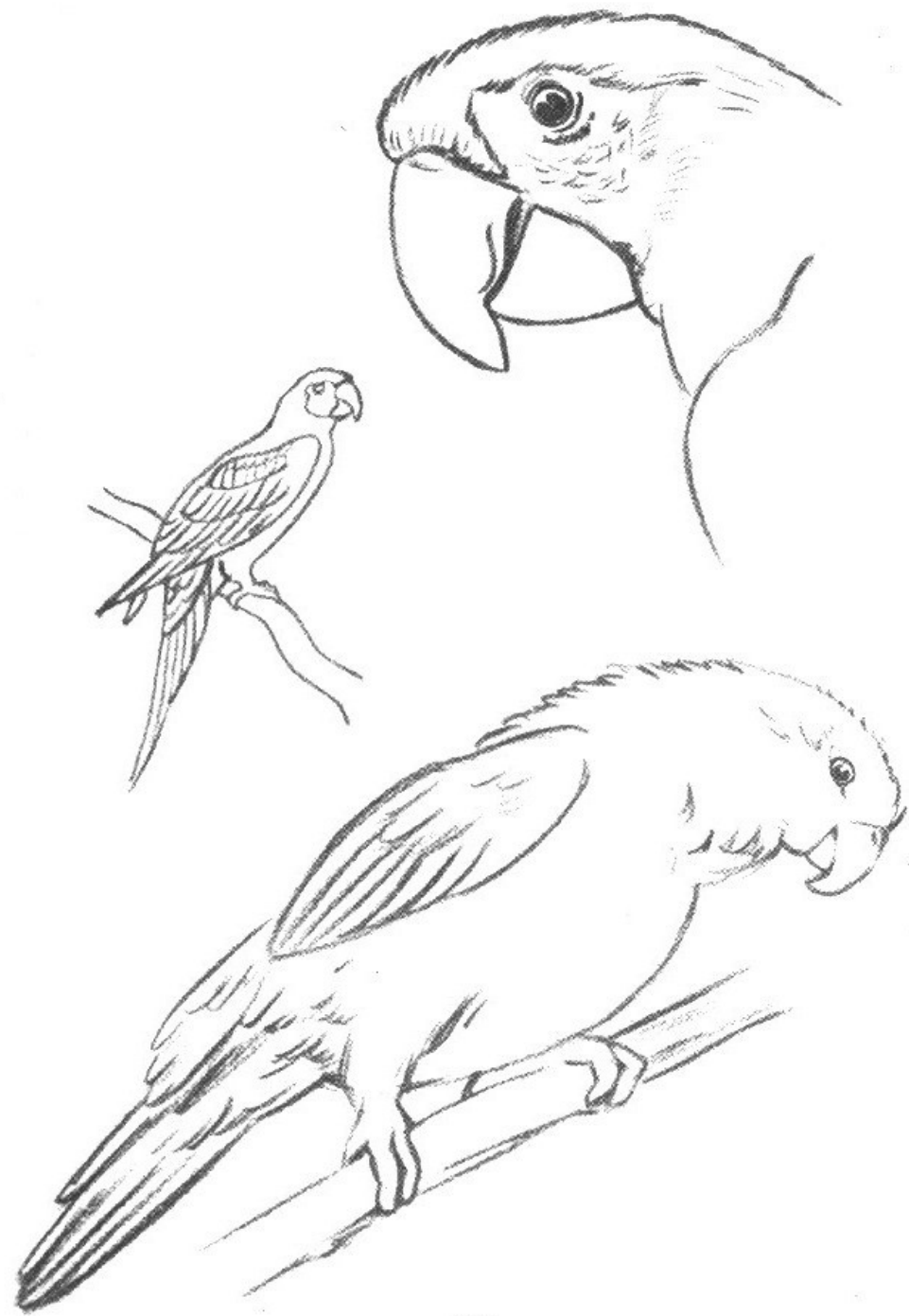
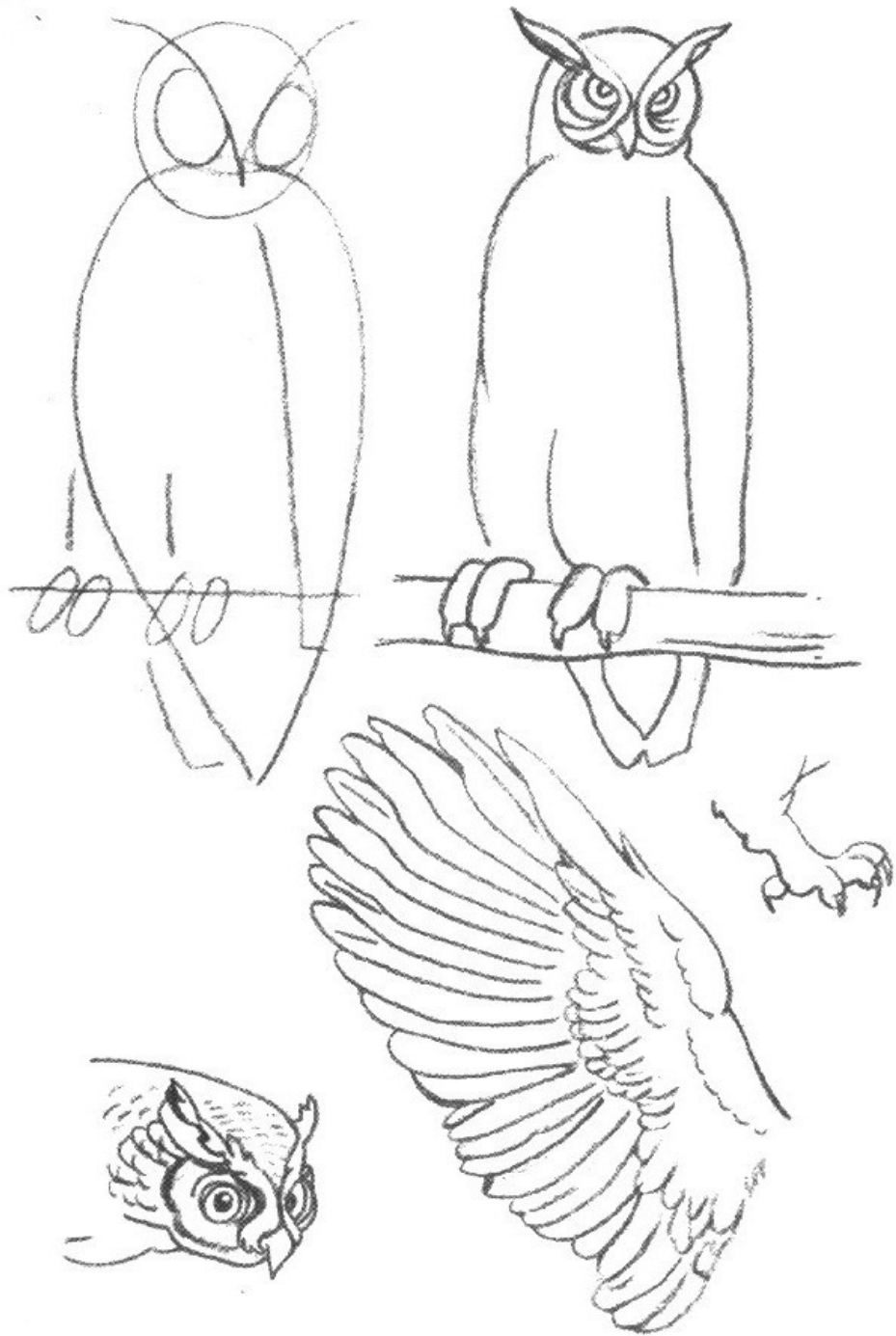

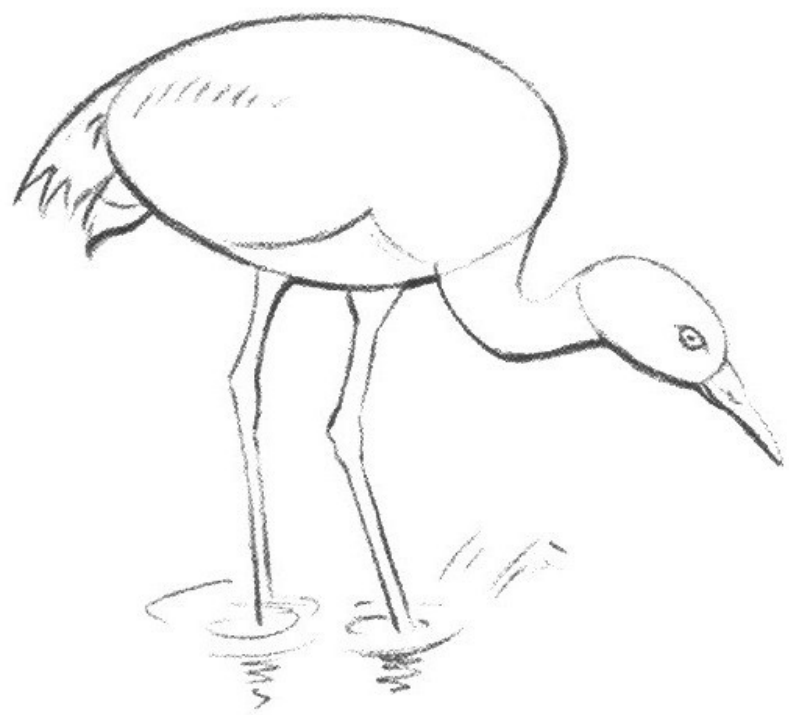
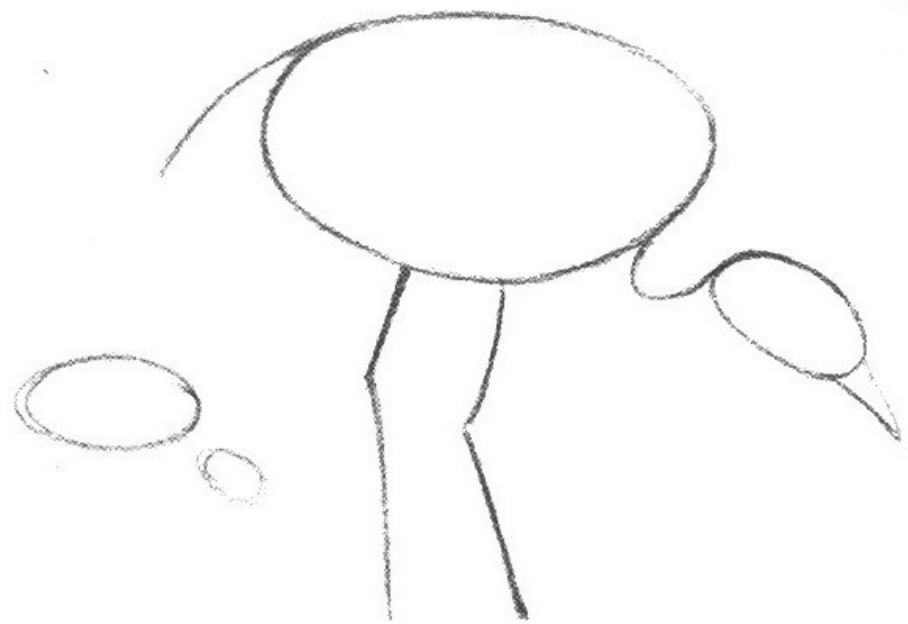

134



135

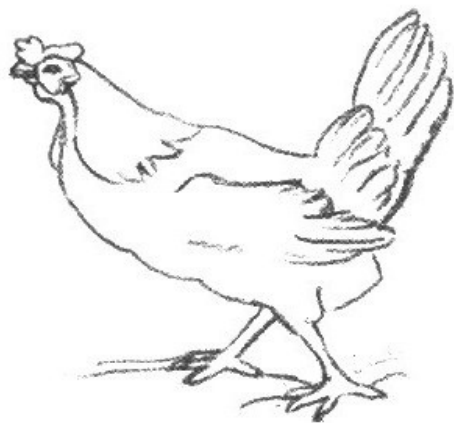
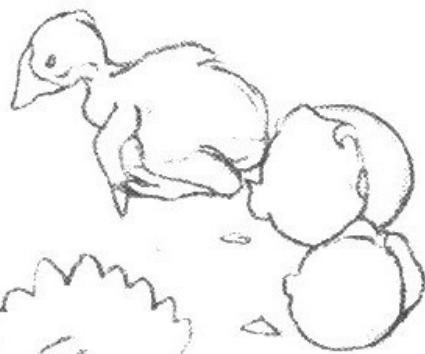
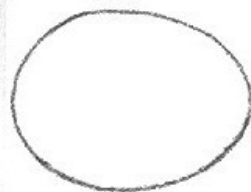
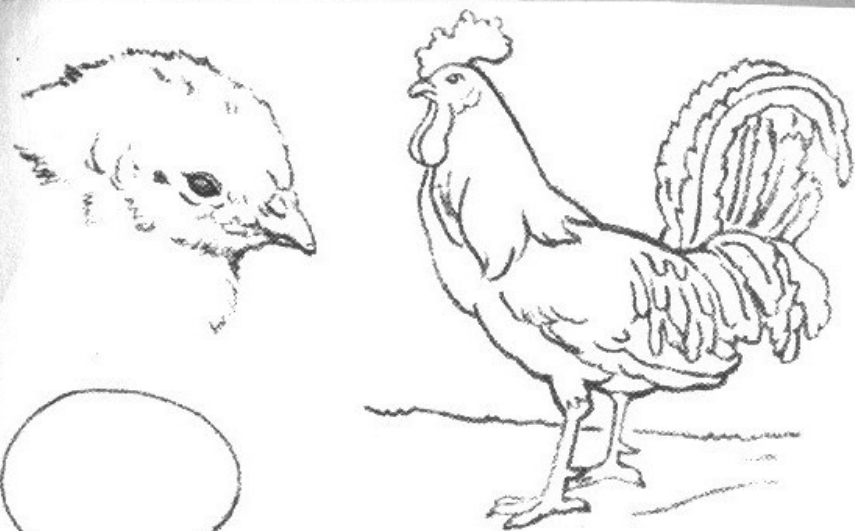
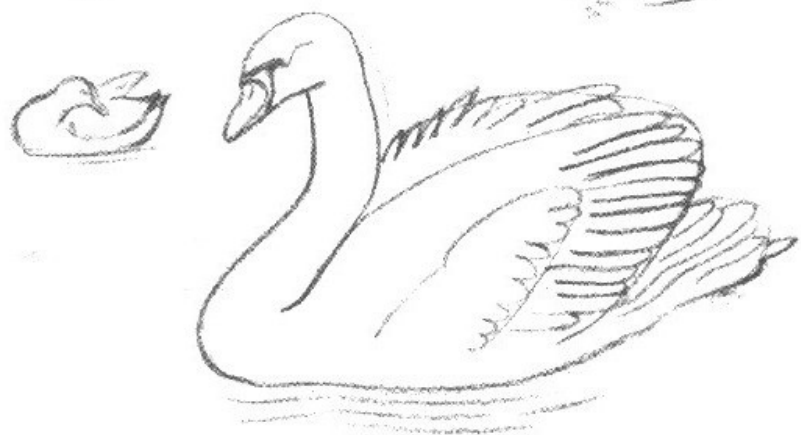
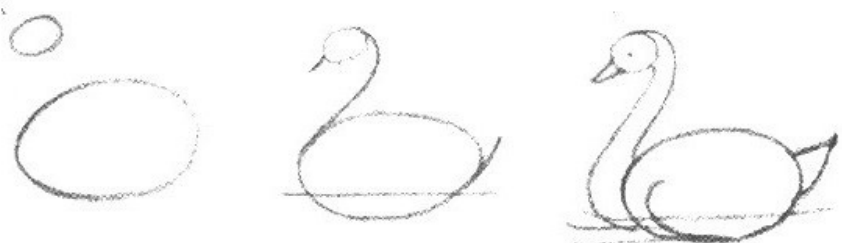

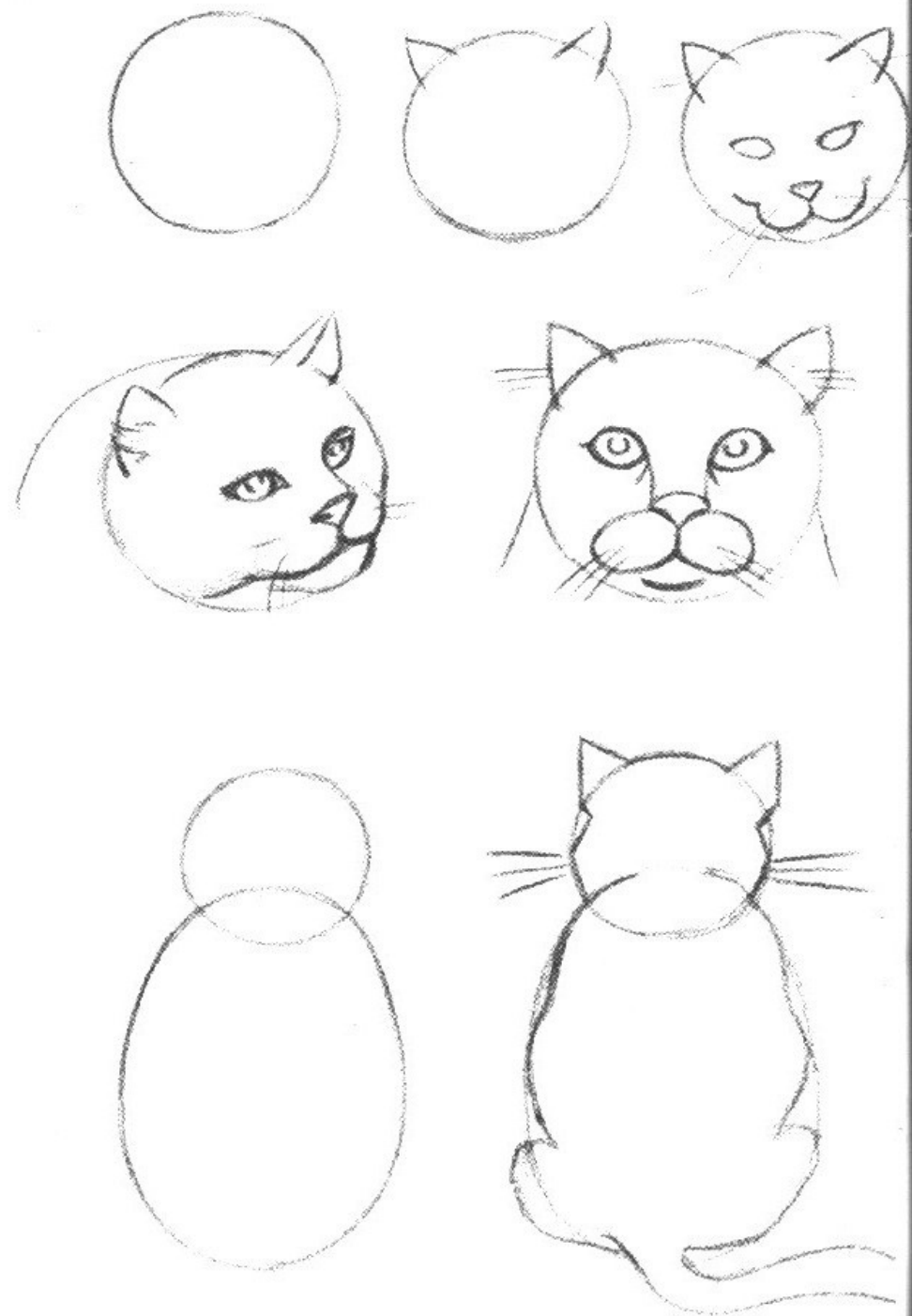
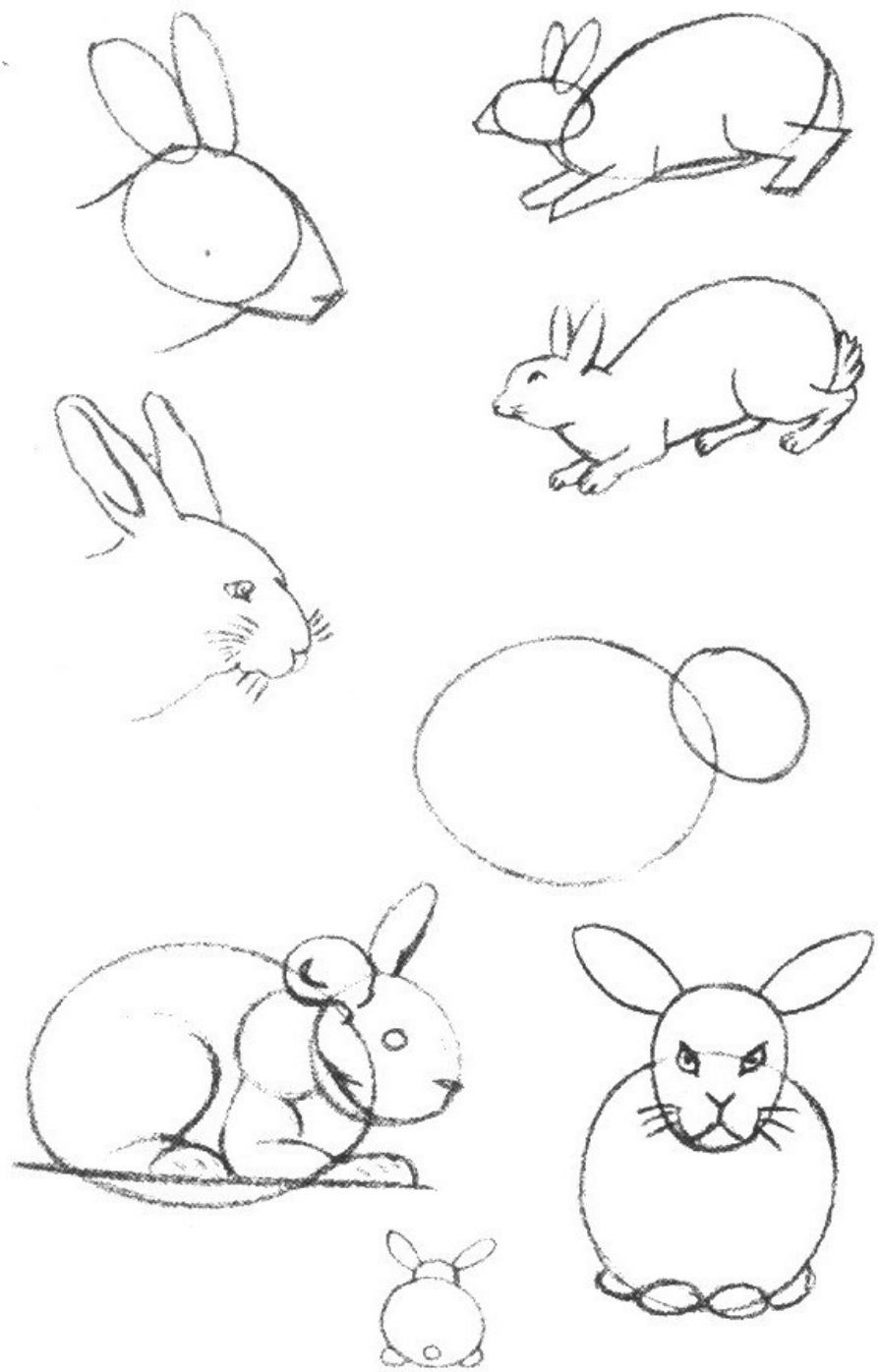

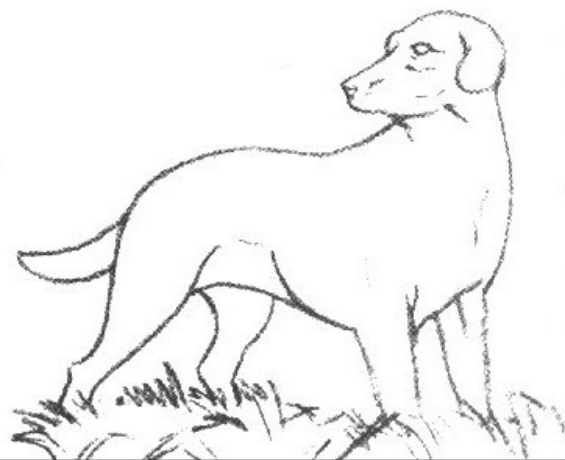
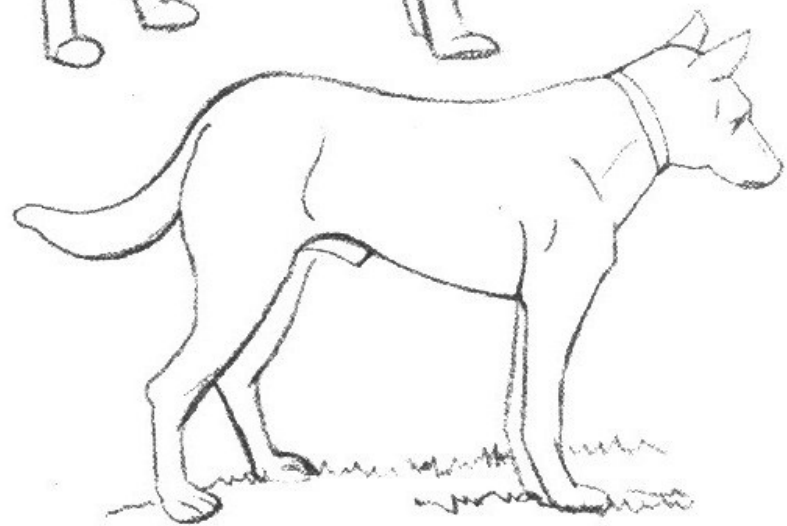
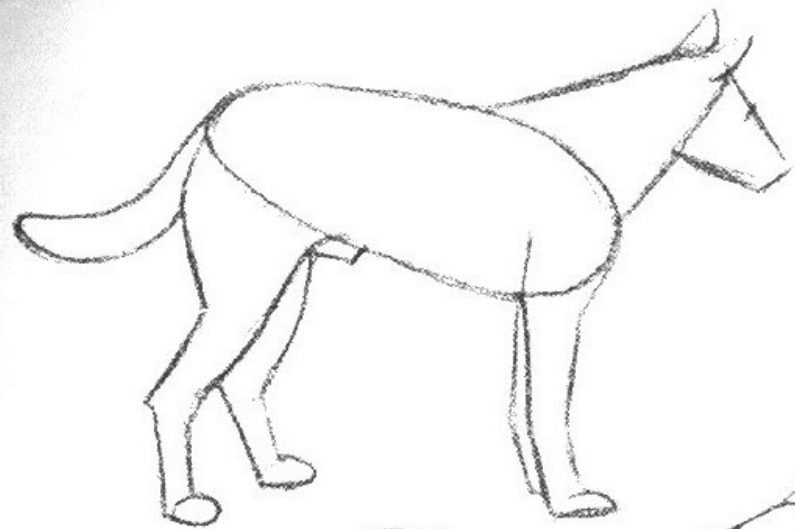

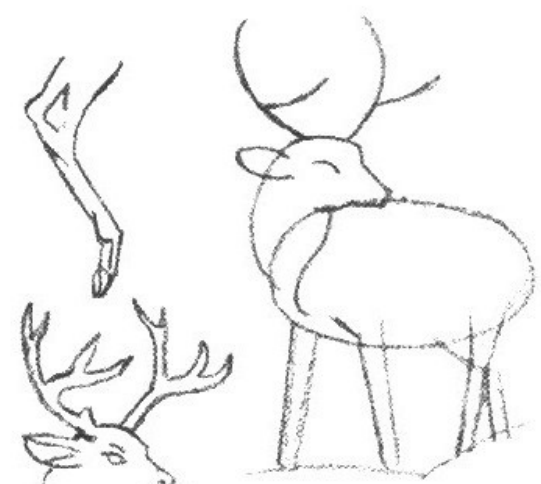
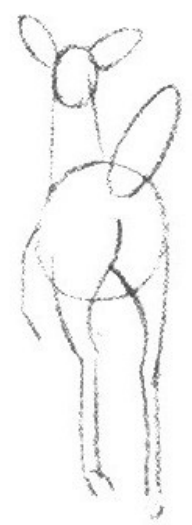
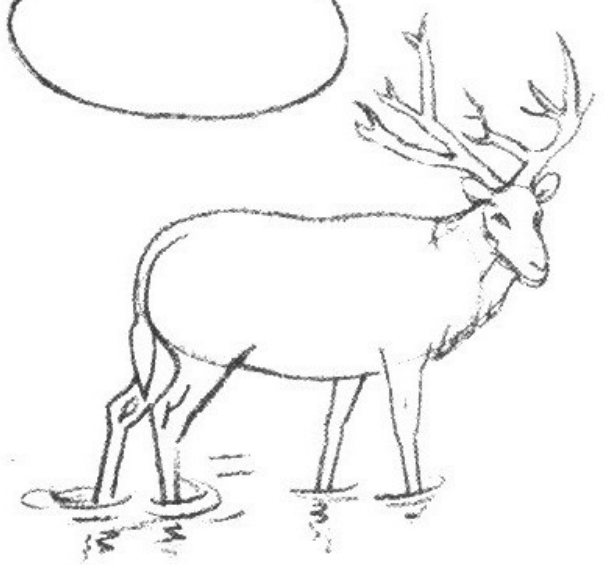
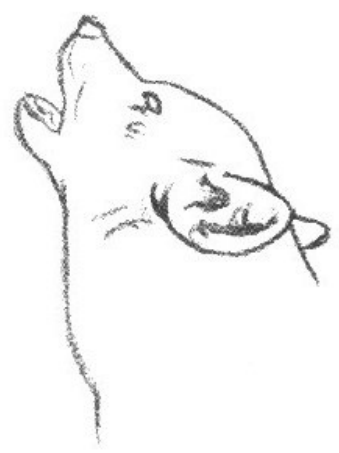
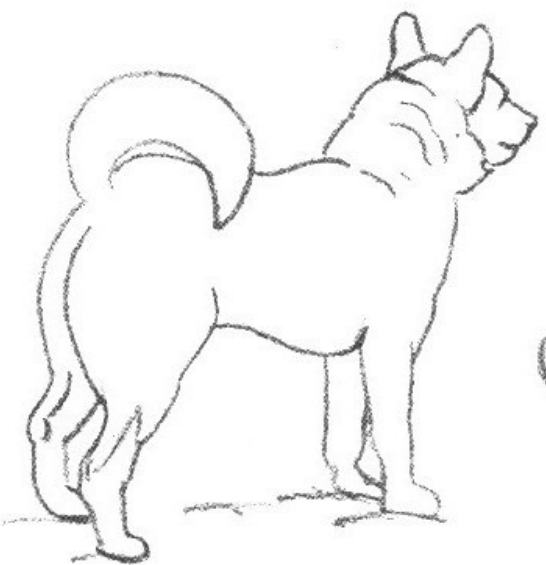
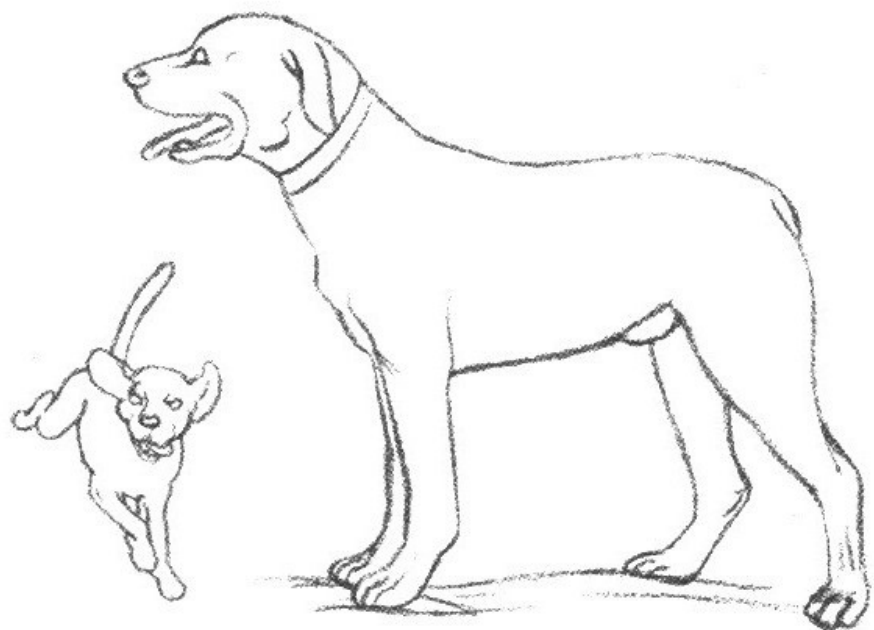

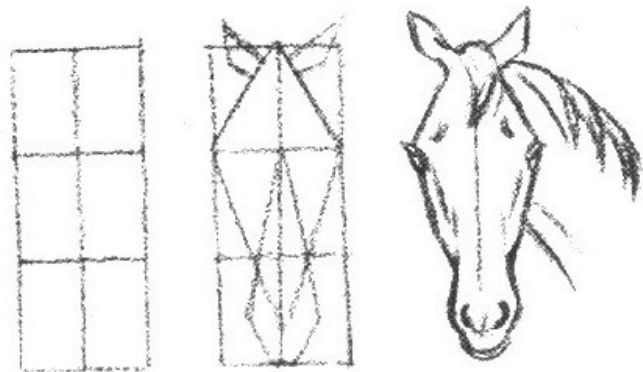
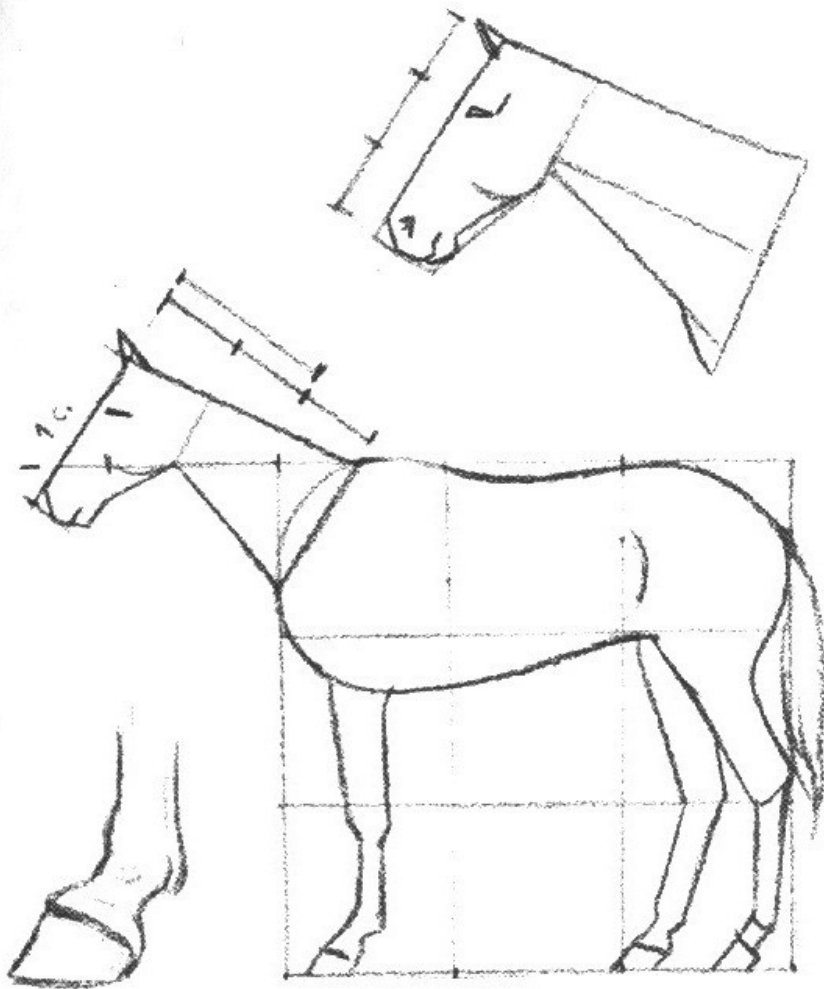
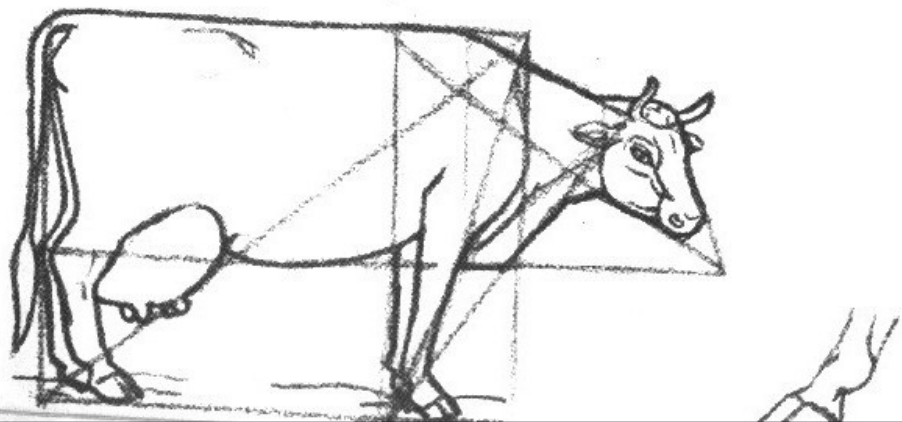
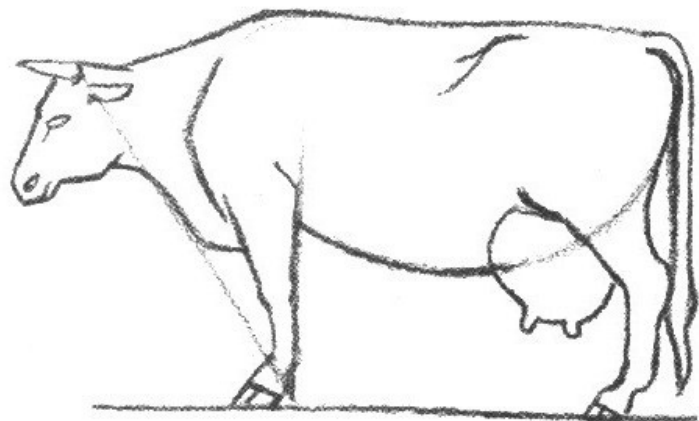
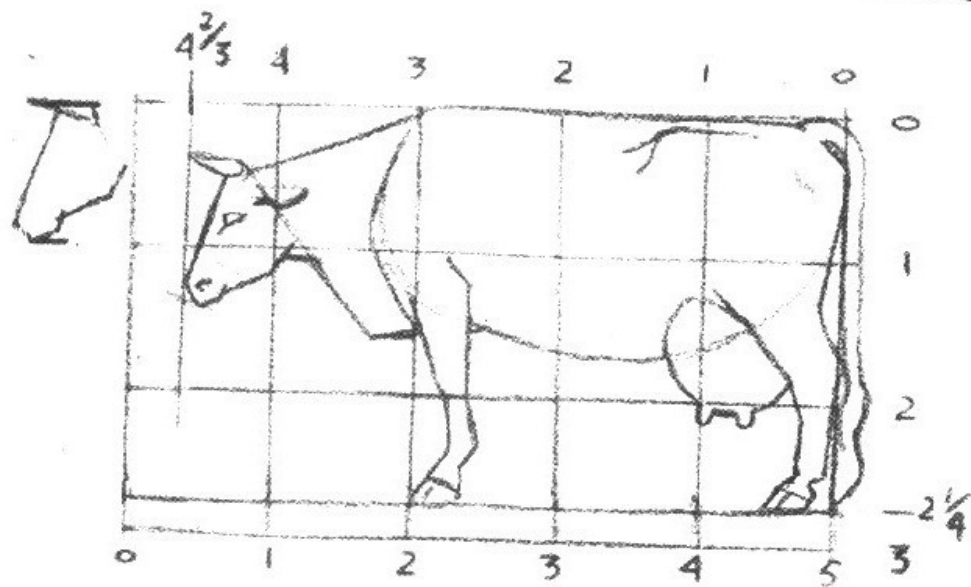

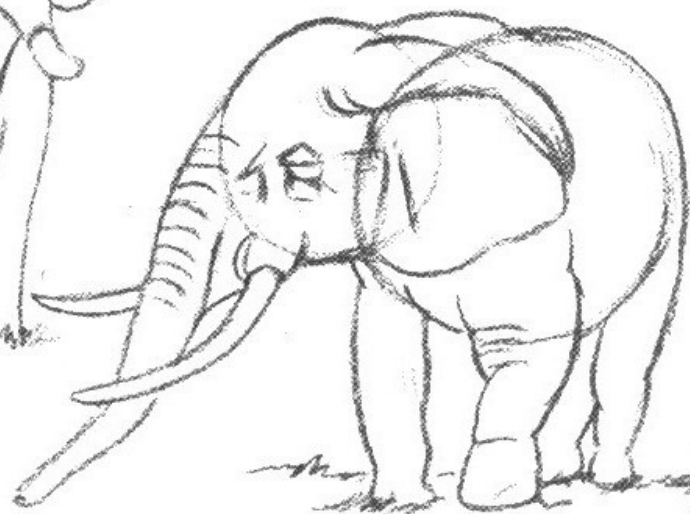
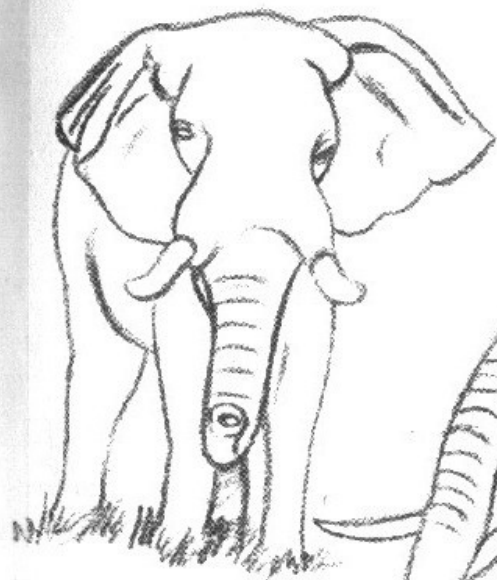
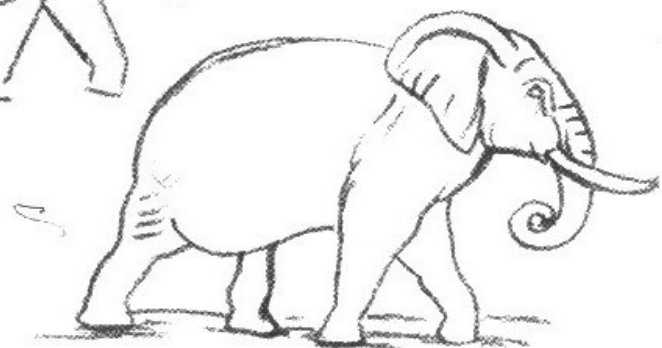
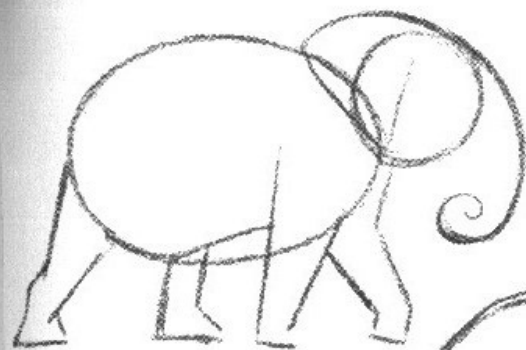
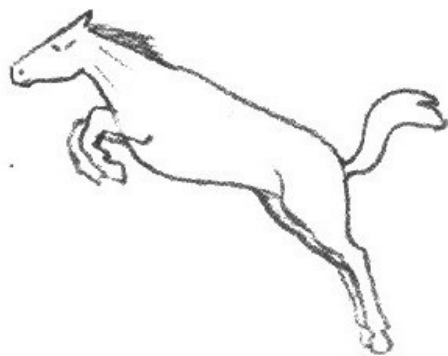
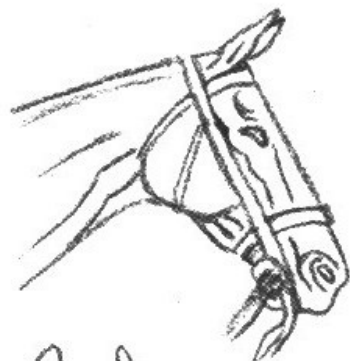
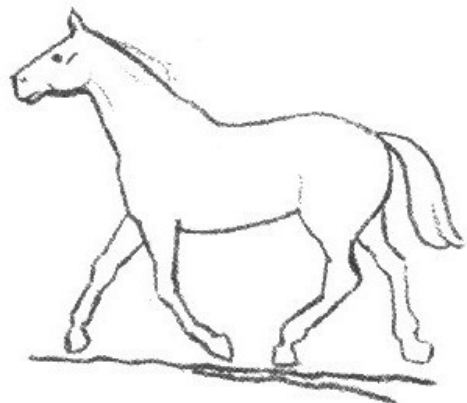
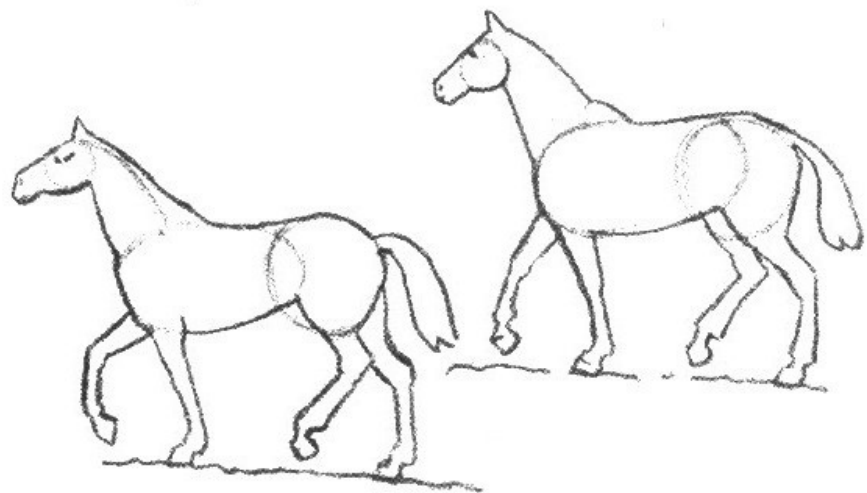

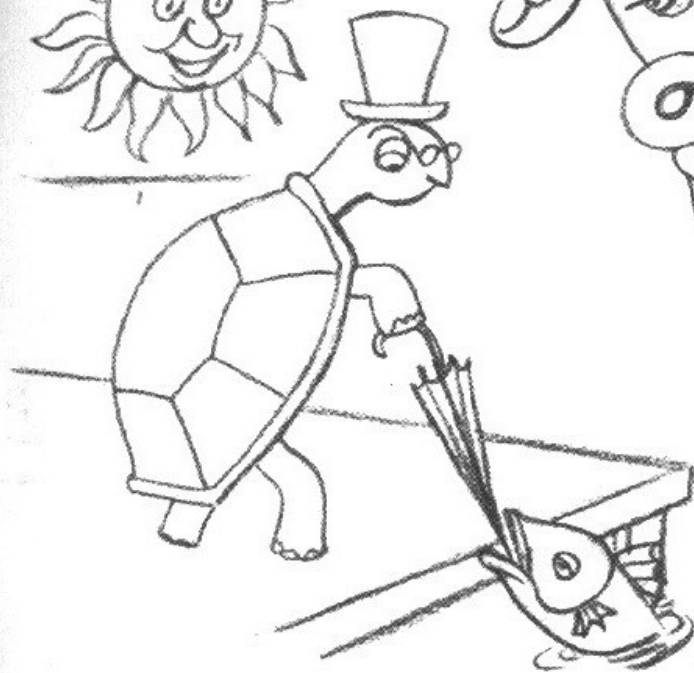
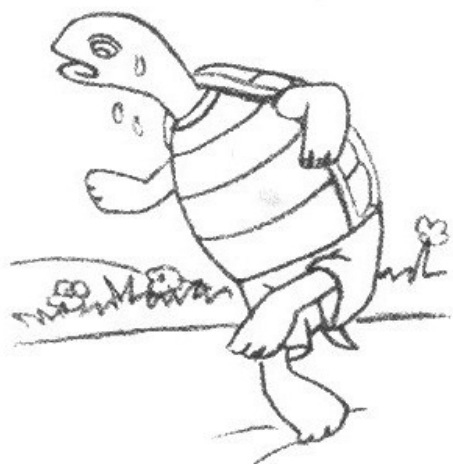

CAPÍTULO VII
*
FIGURA HUMANA

*
* *

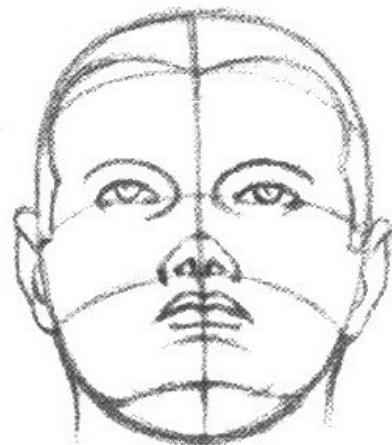
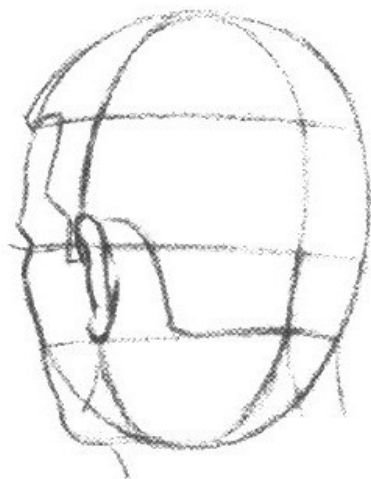
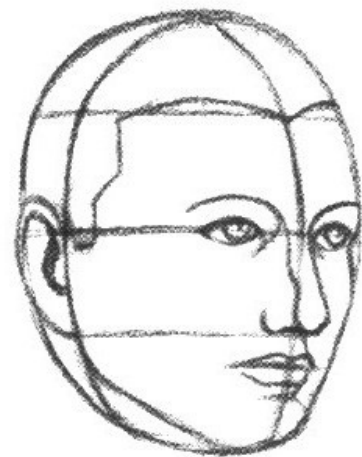
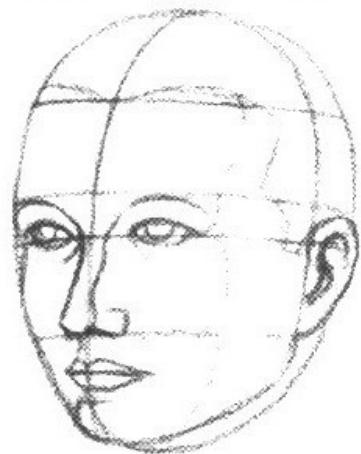
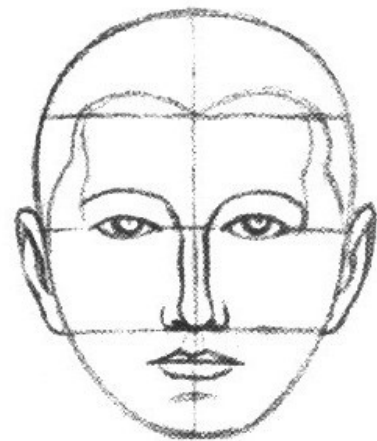



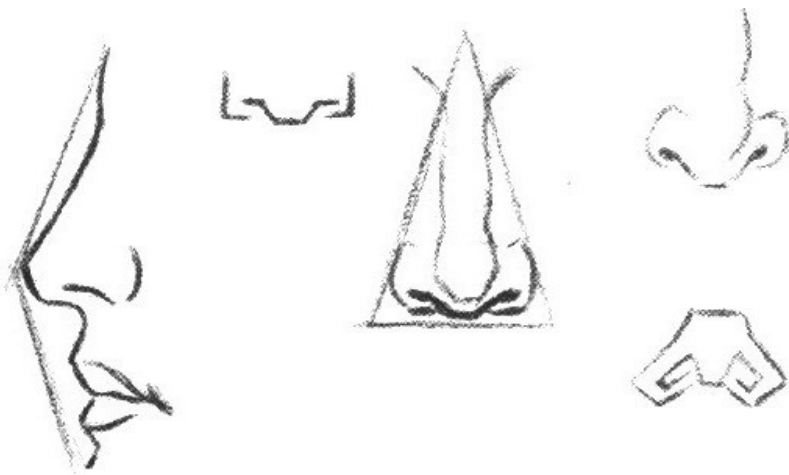



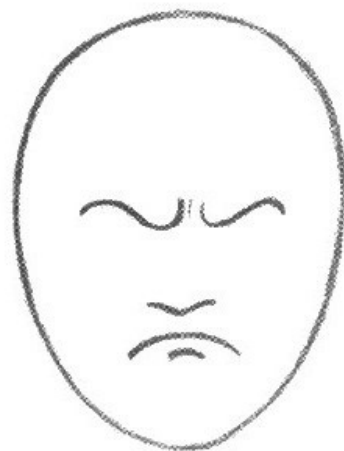
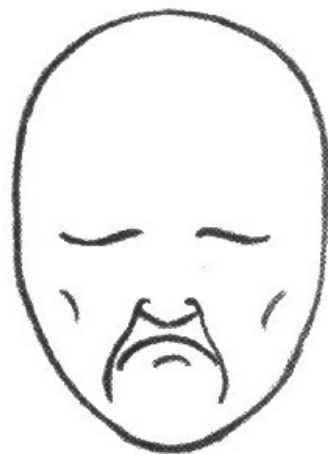
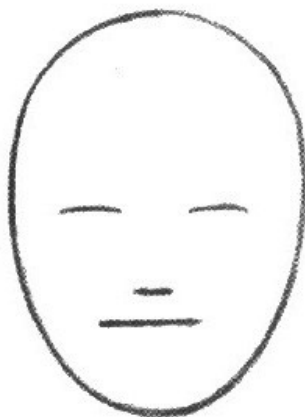

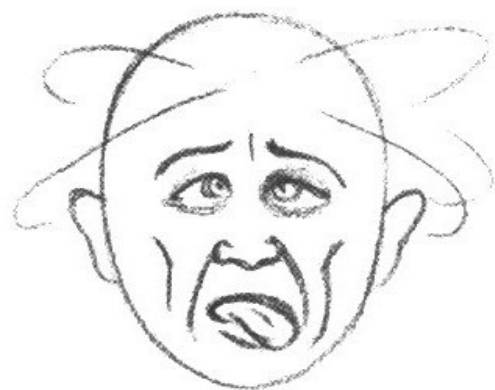
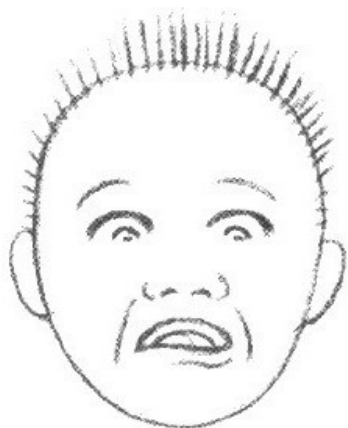
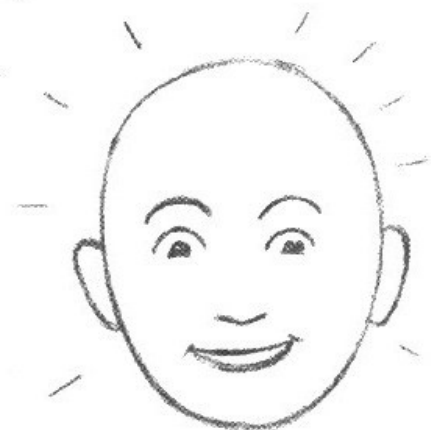

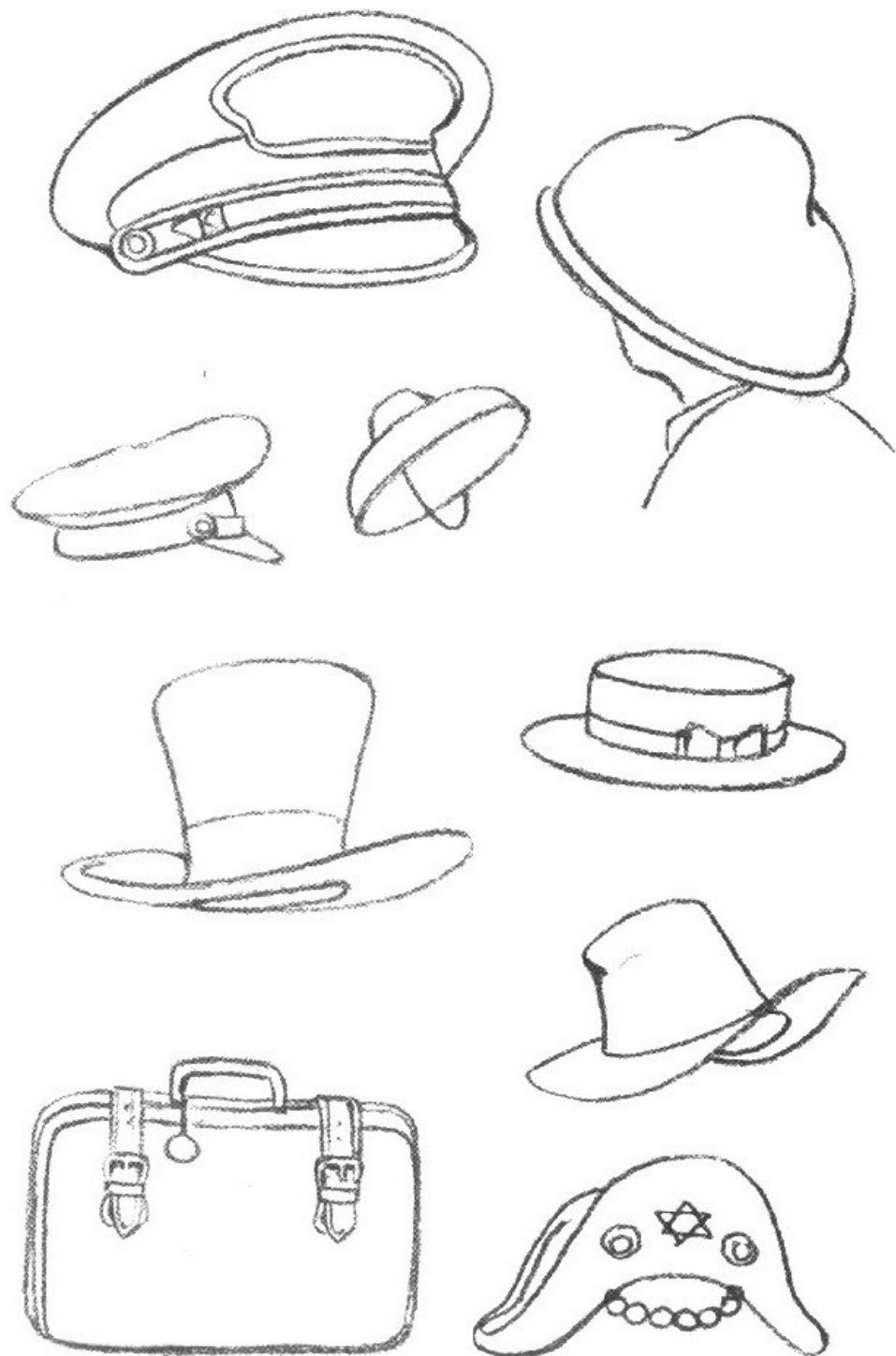

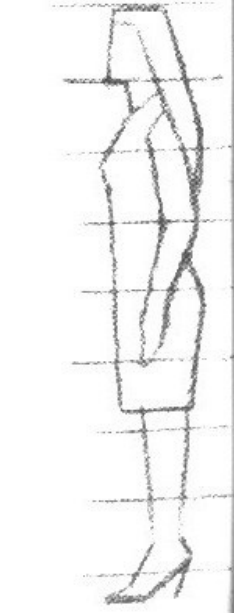
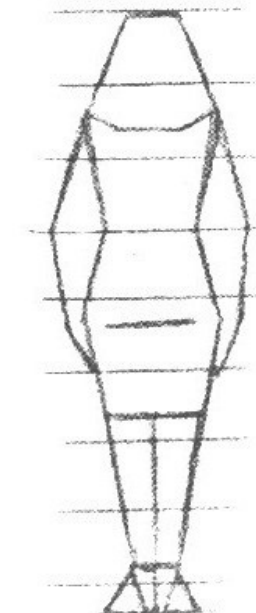
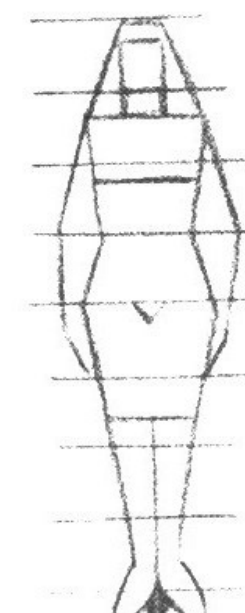
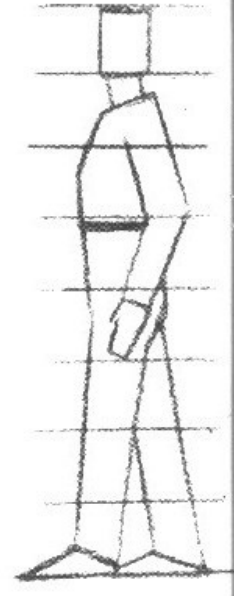
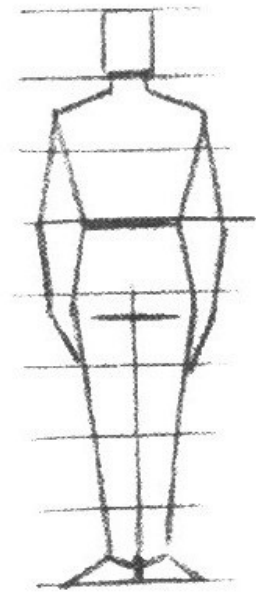
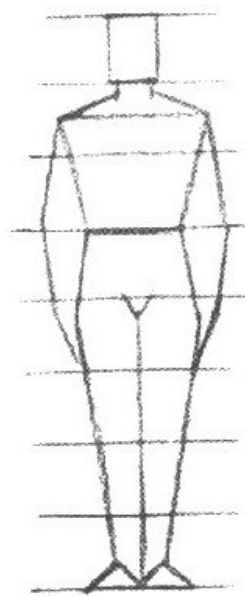
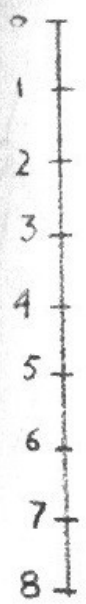
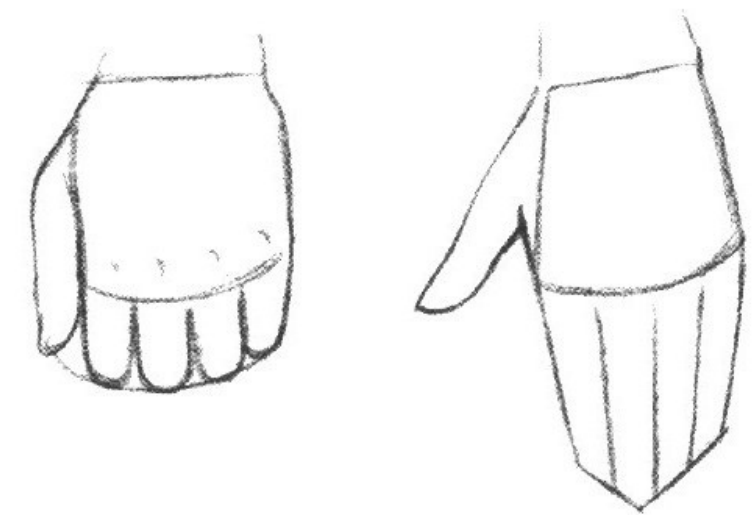
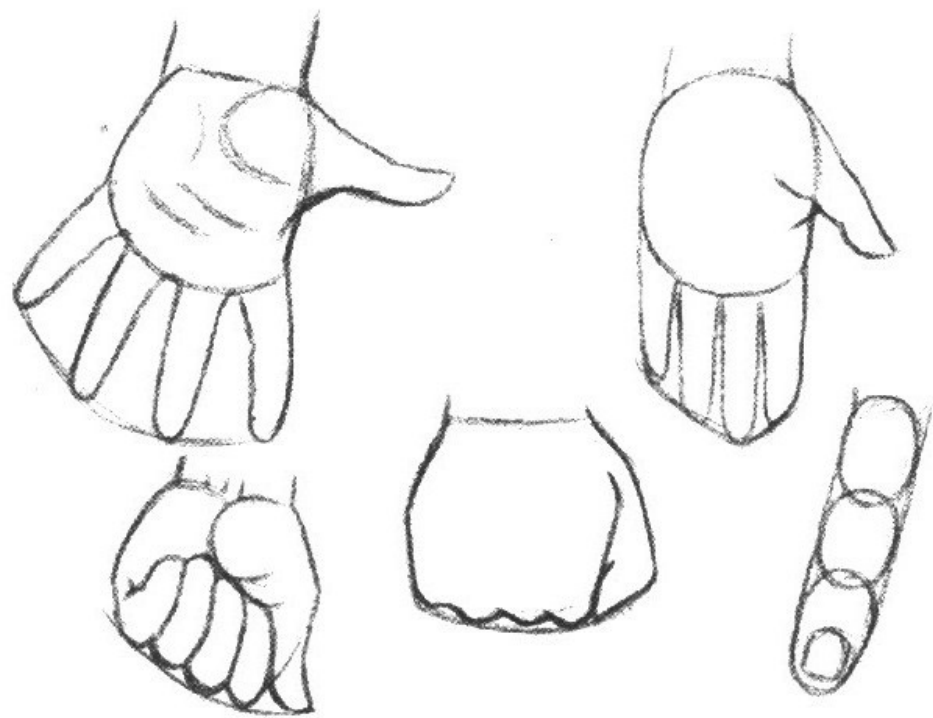

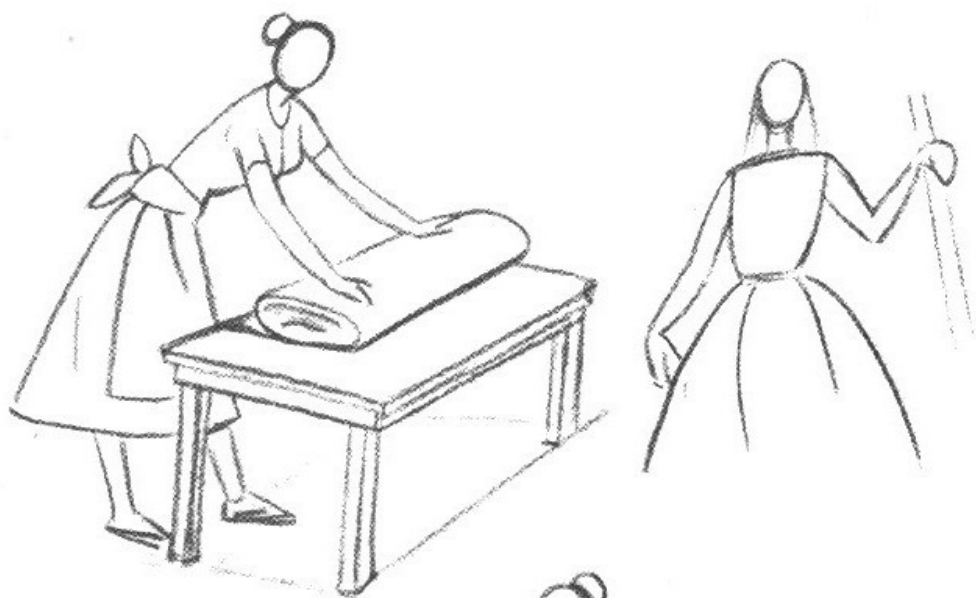

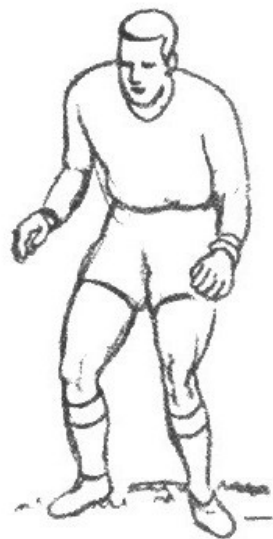

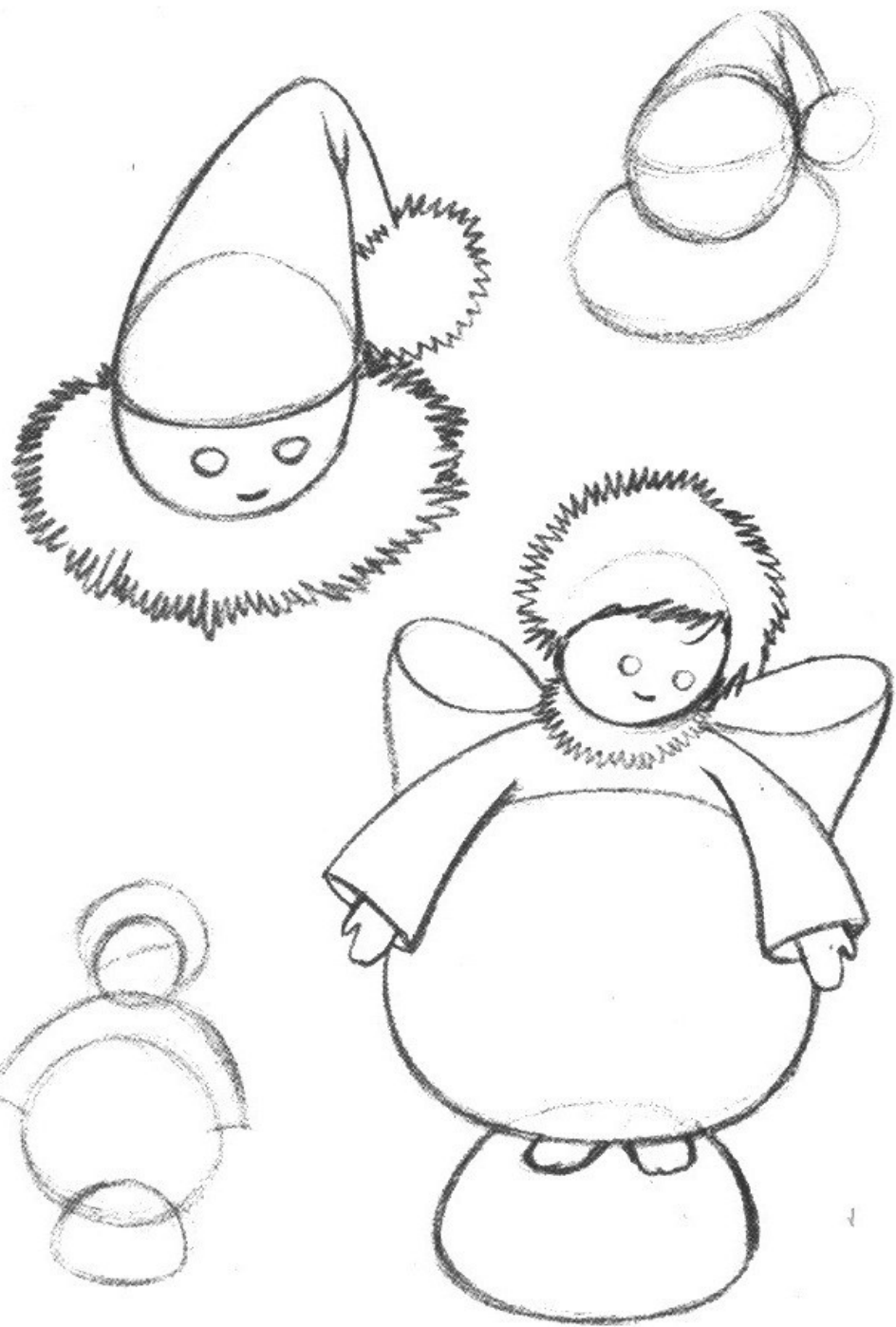



**Edições
de Ouro**



CX. POSTAL 1880
CEP 20000
RIO DE JANEIRO — RJ

Queiram remeter por Reembolso Postal os livros:
(indique os nomes ou os n.ºs)

Não mande nada adiantado — Pedido mínimo: 3 livros)
Você paga no Correio ao retirar o volume.
Leve Identidade (indispensável).

PREÇOS Os livros serão remetidos ao preço atual sem qualquer acréscimo, conforme as categorias abaixo. (Pelo preço do livro que tem em mãos, é possível avaliar os outros.)

GOIA (GT) — 2 livros
• SELD (SU) • ESTRELA (ES) • COPA (CP) • COROA (CR)
• LEÃO (LE) • ÁGUA (AG) • PALMA (PL) • 2 COROAS (ZCR) • 2 LEÕES (ZLE)
• 2 ÁGUIAS (ZAG) • 2 PALMAS (ZPL)

Nome

Endereço

Cidade

CEP n.º

Estado

**Edições
de Ouro**



CX. POSTAL 1880
CEP 20000
RIO DE JANEIRO — RJ

Queiram remeter por Reembolso Postal os livros:
(indique os nomes ou os n.ºs)

(Não mande nada adiantado — Pedido mínimo: 3 livros)
Você paga no Correio ao retirar o volume.
Leve Identidade (indispensável).

PREÇOS Os livros serão remetidos ao preço atual sem qualquer acréscimo, conforme as categorias abaixo. (Pelo preço do livro que tem em mãos, é possível avaliar os outros.)

GOIA (GT) — 2 livros
• SELD (SU) • ESTRELA (ES) • COPA (CP) • COROA (CR)
• LEÃO (LE) • ÁGUA (AG) • PALMA (PL) • 2 COROAS (ZCR) • 2 LEÕES (ZLE)
• 2 ÁGUIAS (ZAG) • 2 PALMAS (ZPL)

Nome

Endereço

Cidade

CEP n.º

Estado



*Desenhar à mão livre
não é difícil. Se você
começar do exercício
mais simples para o
mais complexo, vai
tornar-se um excelente
desenhista. Dentro de
um método objetivo,
DESENHO À MÃO
LIVRE lhe indica como
deve exercitar as
mãos, a visão — o traço.*

EDIÇÕES DE OURO